



WAREHOUSE CATALOG



John F. Scanlan Supply -PA
14 Union Hill Rd
Conshohocken, PA 19428
Phone: 215-614-5145
jfssupply@johnfscanlan.com

H&B Supply- VA
13843 Redskin Dr
Herndon, VA 20171
Phone: 703-437-3301
vahbsupply@hbproducts.com

H&B Supply-MD
3381 A-B 75th Ave
Hyattsville, MD 20785
Phone: 301-773-5300
mdhbsupply@hbproducts.com

H&B Supply-BALT
717 N Hammonds Ferry Rd, Unit N
Linthicum, MD 21090
Phone: 410-563-4705
baltimore.warehouse@hbproducts.com

Diffusers **1-4**

- Perforated Diffuser
- High Performance Diffuser
- Insulation Blanket
- Louvered Face Diffusers
- Architectural (Plaque) Diffusers

Grilles **5-7**

- Deflection Supply / Return Grille
- Eggcrate Return Grille
- Deflection Louvered Filter Grille

Air Device Accessories **9-10**

- Steel Dampers
- Cable Operated Damper
- Trim Frame
- Curved Light Shields

Linear Diffusers **11-14**

- Architectural Linear Diffuser and Flowbar Accessories
- Linear Slot Diffuser
- Plenum
- Plenum Slot Diffusers

Metaire **15-22**

- Louvered and Plaque Diffuser
- Perforated Diffuser
- Damper
- Frame
- Slot Diffuser
- Grilles
- Supply Register

VAV	23-24
Air Volume Diffuser	
Accessories	
Single Duct Terminal	
Water Coil	
H&B Fans (Only ships within DC, MD, VA)	25
Loren Cook Fans & Ventilators	
Broan Fans	
JFS Fans (Only ships within DE, NJ, PA)	26
PennBarry Fans	
Fan Accessories	27
PennBarry, Loren Cook, Weather Caps, Roof Curbs	
Roof Support	28
Frame Kit	
Volcano	
Rails	
Roof Curbs	
Duct Dampers	29
Fire Damper	
Backdraft Damper	
Access Doors and Louvers	30
Access Doors and Louvers	
Sheet Metal	31-34
Square to Round and Round to Round	
Sheet Metal	
Duct Sealer, Flex duct, & Duct Accessories	
Straps and Bands	
Spiral Grilles	
Hang Fast	
Spiral and Fittings	
Terms & Conditions	35



WAREHOUSE STOCK CATALOG

Introduction

Count on H&B and JFS to address construction emergencies promptly and accelerate quick-builds. Our extensive inventory of carefully selected materials is regularly updated to ensure they meet your needs and maximize productivity on the job-site. From air devices, dampers, filters, and louvers to mechanical applications like fans and split systems, our Warehouse Managers and customer service personnel are experts in our products. We welcome discussions about your specific product and delivery requirements so that we can deliver exceptional service to you.

4 EXPANSIVE WAREHOUSE LOCATIONS

ABUNDANTLY STOCKED AND

READY TO SERVE

LOCATIONS AND CONTACTS

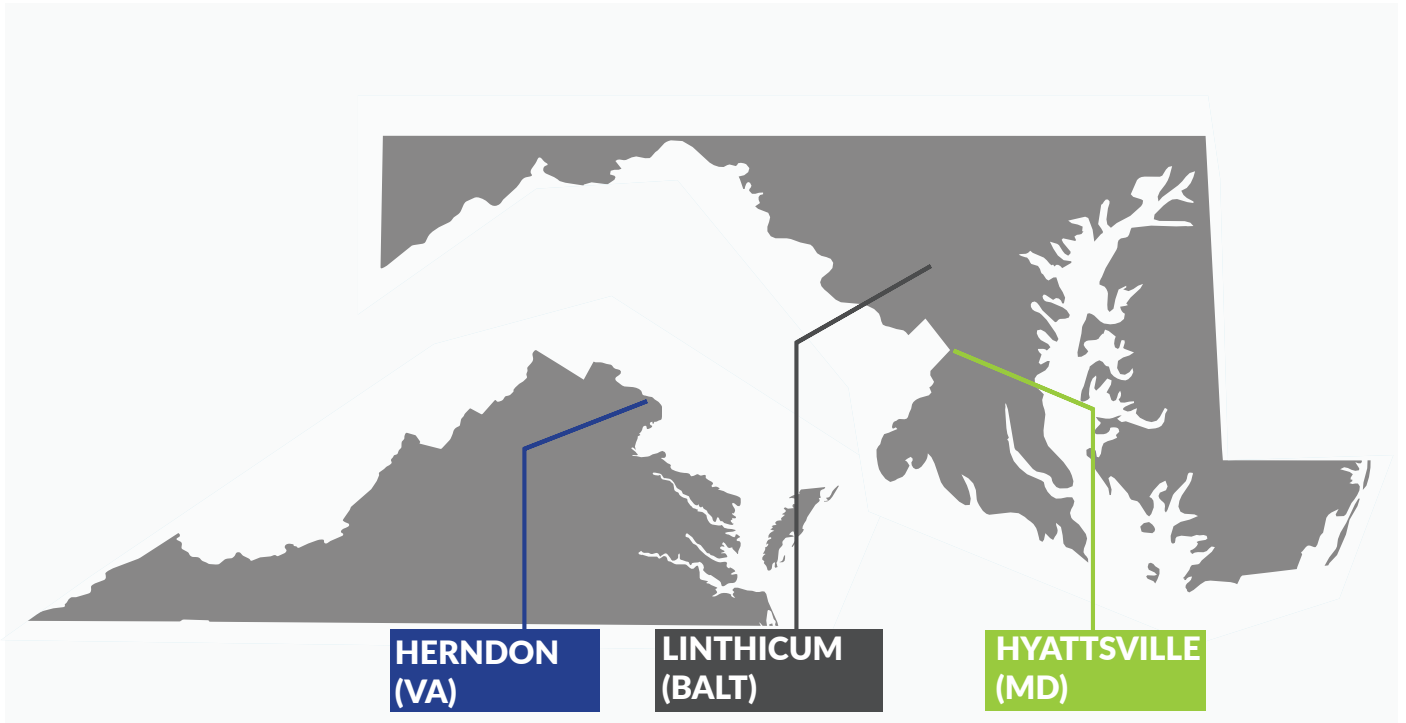

Name	Email	Phone
Linthicum (Balt)	baltimore.warehouse@hbproducts.com	410-563-4705
Hyattsville (MD)	mdhbsupply@hbproducts.com	301-773-5300
Herndon (VA)	vahbsupply@hbproducts.com	703-437-3301
Conshohocken (PA)	jfssupply@johnfscanlan.com	215-614-5145

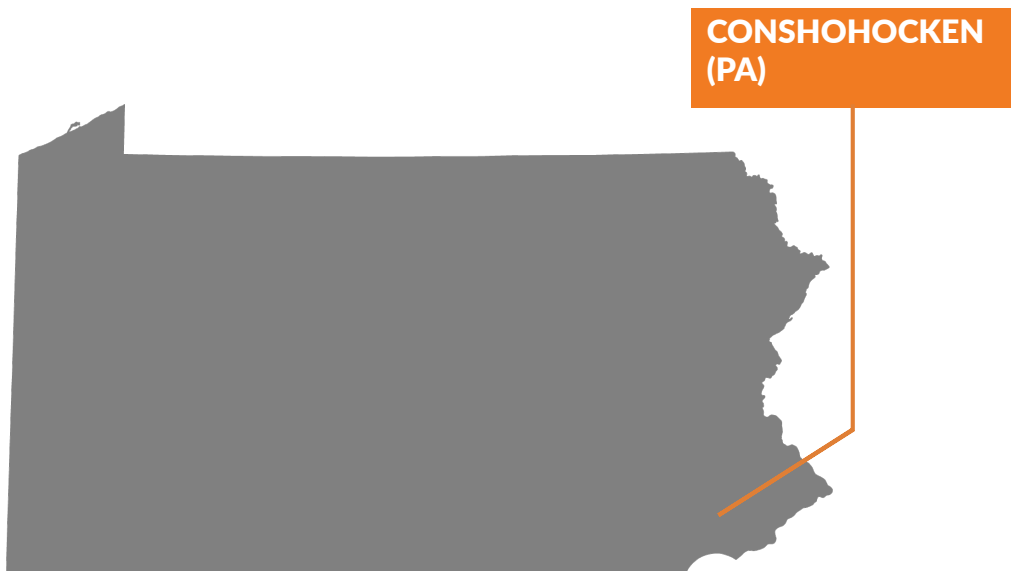

DIFFUSERS

TITUS

PAS

Steel Perforated Diffuser with Face Mounted Deflectors

Titus perforated ceiling diffusers are designed for both heating and cooling applications. A tight, uniform, horizontal blanket of air protects the ceiling against smudging. Discharge pattern is easily adjusted by unlatching and dropping the perforated face, then rotating the pattern controllers.

MODEL	MOUNT	MODULE SIZE	NECK SIZE	CFM RANGE	LOCATION
PAS	Lay - In	12 x 12	6"rd	60-180	Balt, MD, VA, PA
PAS	Lay - In	24 x 24	6"rd	60-180	Balt, MD, VA, PA
PAS	Lay - In	24 x 24	8"rd	105-270	Balt, MD, VA, PA
PAS	Lay - In	24 x 24	10"rd	165-365	Balt, MD, VA, PA
PAS	Lay - In	24 x 24	12"rd	235-470	Balt, MD, VA, PA
PAS	Lay - In	24 x 24	14"rd	325-575	Balt, MD, VA, PA
PAS	Lay - In	24 x 24	16"rd	420-675	Balt, MD, VA, PA
PDS VA and MD only					



TITUS

PCS/PCS-DF

Steel Perforated Neck-Mounted Curved Blade Deflectors

Titus Series PCS ceiling diffusers are designed for longer throws. Discharge patterns can be adjusted from either horizontal to vertical before or after installation. Available for drop face ceiling as well.

MODEL	MOUNT	MODULE SIZE	NECK SIZE	CFM RANGE	LOCATION
PCS / PCS-DF	Lay - In	24 x 24	6"rd	60-110	MD, VA
PCS / PCS-DF	Lay - In	24 x 24	8"rd	105-180	MD, VA
PCS / PCS-DF	Lay - In	24 x 24	10"rd	165-270	MD, VA
PCS / PCS-DF	Lay - In	24 x 24	12"rd	235-365	MD, VA
PCS / PCS-DF	Lay - In	24 x 24	14"rd	235-365	MD, VA

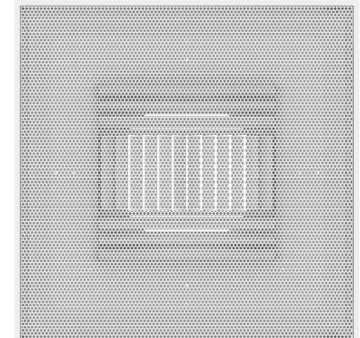

TITUS

PSS/PSS-DF

Steel Perforated Supply Diffuser with Star Pattern Deflector

Titus Series PSS perforated star diffusers generate a high induction air pattern that maximizes throw. A deflector is mounted directly under the neck of the diffuser to generate the long-throw star pattern. As a result, pressure drop and noise levels are lower than typical curved blade perforated diffusers. Available for drop face ceiling as well.

MODEL	MOUNT	MODULE SIZE	NECK SIZE	CFM RANGE	LOCATION
PSS / PSS-DF	Lay - In	24 x 24	6"rd	60-145	MD, VA
PSS / PSS-DF	Lay - In	24 x 24	8"rd	105-245	MD, VA
PSS / PSS-DF	Lay - In	24 x 24	10"rd	165-360	MD, VA
PSS / PSS-DF	Lay - In	24 x 24	12"rd	235-490	MD, VA
PSS / PSS-DF	Lay - In	24 x 24	14"rd	320-650	MD, VA

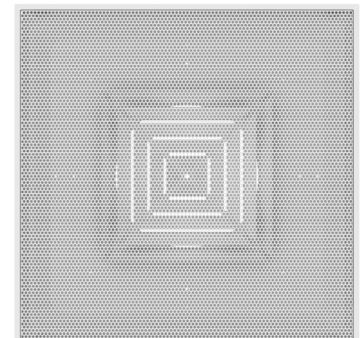

PAR

TITUS

Steel Perforated Return Diffuser

Titus return perforated ceiling diffusers have the same face and border construction as the supply models, for harmonious appearance in the room. Deflectors removed from PDS to create PDR.

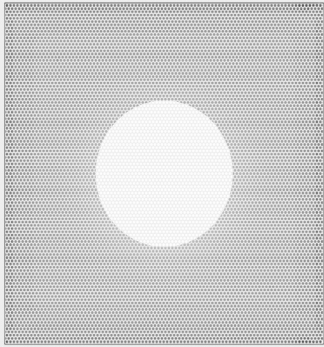

MODEL	MOUNT	MODULE SIZE	NECK SIZE	CFM RANGE	LOCATION
PAR	Lay - In	12 x 12	10 x 10	375	Balt, MD, VA, PA
PAR	Lay - In	12 x 12	6" rd*	225	MD, VA, PA
PAR	Lay - In	24 x 12	22 x 10	1700	Balt, MD, VA, PA
PAR	Lay - In	24 x 24	6" rd*	200	Balt, MD, VA
PAR	Lay - In	24 x 24	8" rd*	325	Balt, MD, VA, PA
PAR	Lay - In	24 x 24	10" rd*	450	Balt, MD, VA, PA
PAR	Lay - In	24 x 24	12" rd*	575	Balt, MD, VA, PA
PAR	Lay - In	24 x 24	14" rd*	900	Balt, MD, VA, PA
PAR	Lay - In	24 x 24	16" rd*	900	Balt, MD, VA, PA
PAR	Lay - In	24 x 24	6 x 6	425	Balt, MD, VA
PAR	Lay - In	24 x 24	8 x 8	425	Balt, MD, VA, PA
PAR	Lay - In	24 x 24	10 x 10	550	Balt, MD, VA, PA
PAR	Lay - In	24 x 24	12 x 12	750	Balt, MD, VA, PA
PAR	Lay - In	24 x 24	15 x 15	1050	Balt, MD, VA, PA
PAR	Lay - In	24 x 24	18 x 18	1400	Balt, MD, VA, PA
PAR	Lay - In	24 x 24	22 x 22	2000	Balt, MD, VA, PA
PAR	Lay - In	48 x 24	46 x 22	4220	Balt, VA, PA

PXP

TITUS

Steel Perforated Return Panel

Model PXP Series perforated panels are designed for return or exhaust applications. Panels match Models PAS, PDS, and PAS-AA supply diffusers in appearance after installation.

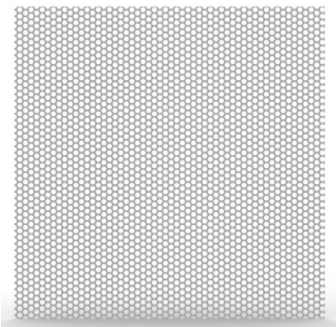

MODEL	MOUNT	MODULE SIZE	NECK SIZE	CFM RANGE	LOCATION
PXP	Lay - In	12 x 12	-----	500	VA
PXP	Lay - In	24 x 12	-----	1000	VA
PXP	Lay - In	24 x 24	-----	2000	Balt, MD, VA, PA
PXP-NT	Lay - In	24 x 24	-----	2000	MD, VA
PXP-DF	Lay - In	24 x 24	-----	2000	MD, VA

DIFFUSERS

TITUS

TMR/TMRA

Steel, High Performance Three Cone Diffuser

Models TMR and TMR-AA round ceiling diffusers are designed for cooling applications. All sizes have three cones, giving a uniform appearance where different sizes are used in the same area. They deliver a uniform 360° discharge pattern and exhibit excellent performance in variable air volume systems.

MODEL	MOUNT	MODULE SIZE	NECK SIZE	CFM RANGE	LOCATION
TMR	Surface Mount	11.125"	6"rd	80-225	MD, VA, PA
TMR	Surface Mount	14.75"	8"rd	140-375	MD, VA, PA
TMR	Surface Mount	18.25"	10"rd	220-545	MD, VA, PA
TMR	Surface Mount	22"	12"rd	315-710	MD, VA, PA
TMR	Surface Mount	26"	14"rd	425-950	MD, PA
TMR	Surface Mount	29"	16"rd	560-1200	MD
TMR	Surface Mount	32.5"	18"rd	710-1500	MD
TMRA	Surface Mount	13.5"	6"rd	80-165	MD
TMRA	Surface Mount	18"	8"rd	140-280	MD
TMRA	Surface Mount	22.5"	10"rd	220-425	MD
TMRA	Surface Mount	27"	12"rd	315-600	MD
TMRA	Surface Mount	31.5"	14"rd	425-800	MD
TMRA	Surface Mount	36"	16"rd	560-1050	MD
TMRA	Surface Mount	40.5"	18"rd	710-1250	MD



TITUS

TMS

Steel, High Performance Three Cone Diffuser

The TMS is a square ceiling diffuser that delivers supply air in a true 360° pattern with low pressure drop. The uniform, nearly horizontal jet from the outer cone maintains effective room air distribution even when the air volume varies over a considerable range. All sizes have three cones, giving a uniform appearance where different neck sizes are used in the same area.

MODEL	MOUNT	MODULE SIZE	NECK SIZE	CFM RANGE	LOCATION
TMS	Lay - In	12 x 12	6"rd	80-225	Balt, MD, VA, PA
TMS	Lay - In	12 x 12	8"rd	140-350	Balt, MD, VA, PA
TMS	Lay - In	24 x 24	6"rd	80-250	Balt, MD, VA, PA
TMS	Lay - In	24 x 24	8"rd	140-400	Balt, MD, VA, PA
TMS	Lay - In	24 x 24	10"rd	220-570	Balt, MD, VA, PA
TMS	Lay - In	24 x 24	12"rd	315-765	Balt, MD, VA, PA
TMS	Lay - In	24 x 24	14"rd	430-965	Balt, MD, VA, PA
TMS	Lay - In	24 x 24	15"rd	430-965	Balt, MD, VA

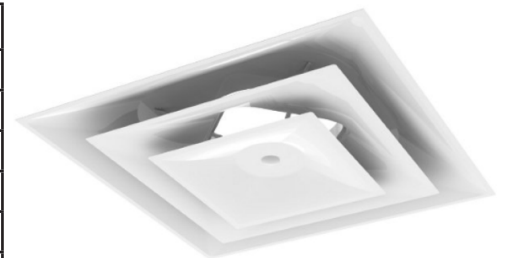

ACCESSORIES

SQUARE DIFFUSERS

MODEL	MATERIAL	LOCATION
Insulation Blanket	R6.0 Insulation Blanket for 24 x 24 Diffusers	Balt, MD, VA, PA

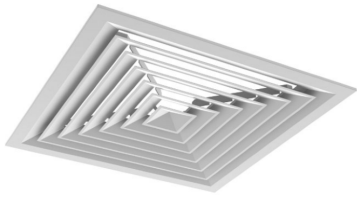

BLOW PATTERNS AVAILABLE:
A4 = 4 WAY BLOW (DEFAULT)
A3 = 3 WAY BLOW
S2 = 2 WAY BLOW, OPPOSED
G2 = 2 WAY BLOW, CORNER
S1 = 1 WAY BLOW

TDC

TITUS

Steel Louvered Face Diffuser

Titus Series TDC diffusers handle an unusually large amount of air for a given pressure drop and noise level. Their pleasing appearance harmonizes with various architectural details, especially in modular ceiling systems.

MODEL	MOUNT	MODULE SIZE	NECK SIZE	CFM RANGE	LOCATION
TDC	Lay - In	12 x 12	6 x 6	75-215	Balt
TDC	Lay - In	12 x 12	9 x 9	170-440	Balt
TDC	Lay - In	24 x 24	6 x 6	75-215	Balt, MD, VA, PA
TDC	Lay - In	24 x 24	9 x 9	170-440	Balt, MD, VA, PA
TDC	Lay - In	24 x 24	12 x 12	300-725	Balt, MD, VA, PA
TDC	Lay - In	24 x 24	15 x 15	470-1,075	Balt, MD, VA, PA
TDC	Lay - In	24 x 24	18 x 18	675-1,500	Balt, MD, VA, PA
TDCA	Lay - In	24 x 24	18 x 18	675-1,200	Balt
TDC	SM Border 1	-----	6 x 6	75-215	Balt, MD, VA, PA
TDC	SM Border 1	-----	9 x 9	170-440	Balt, MD, VA, PA
TDC	SM Border 1	-----	12 x 12	300-725	Balt, MD, VA, PA
TDC	SM Border 1	-----	15 x 15	470-1,075	MD, VA, PA
TDC	SM Border 1	-----	18 x 18	675-1,500	MD, VA, PA
TDC	SM Border 6	-----	6 x 6	75-215	Balt, MD, VA
TDC	SM Border 6	-----	9 x 9	170-440	Balt, MD, VA
TDC	SM Border 6	-----	12 x 12	300-725	Balt, MD, VA
TDC	SM Border 6	-----	15 x 15	470-1,075	Balt, MD, VA
TDC	SM Border 6	-----	18 x 18	675-1,500	Balt, MD, VA

OMNI

TITUS

Steel Plaque Face Diffuser for use in Architectural Ceilings

The Titus OMNI is a steel plaque face diffuser that satisfies architectural and engineering criteria. Its strong, clean, unobtrusive lines harmonize with the ceiling system without sacrificing performance. The curvature of the OMNI backpan works with the formed edges of the face panel to deliver a uniform 360 degree horizontal air pattern, without excessive noise or pressure drop. It is an excellent selection for variable air volume systems.

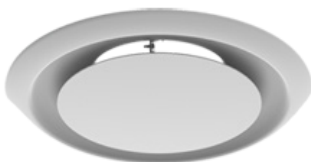
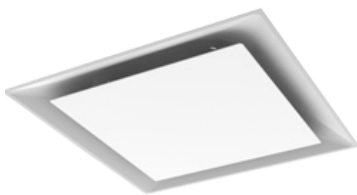

MODEL	MOUNT	MODULE SIZE	NECK SIZE	CFM RANGE	LOCATION
OMNI	Lay - In	12 x 12	6"	80-210	Balt, MD, VA, PA
OMNI	Lay - In	12 x 12	8"	140-380	Balt, MD, VA, PA
OMNI	Lay - In	24 x 24	6"	80-250	Balt, MD, VA, PA
OMNI	Lay - In	24 x 24	8"	140-400	Balt, MD, VA, PA
OMNI	Lay - In	24 x 24	10"	220-575	Balt, MD, VA, PA
OMNI	Lay - In	24 x 24	12"	315-760	Balt, MD, VA, PA
OMNI	Lay - In	24 x 24	14"	430-975	Balt, MD, VA, PA
OMNI	Lay - In	24 x 24	15"	430-975	Balt, MD, VA, PA
R-OMNI	Lay - In	-----	6"	80-240	MD
R-OMNI	Lay - In	-----	8"	140-420	MD
R-OMNI	Lay - In	-----	10"	220-545	MD

NT available at MD and VA only

DB accessory for OMNI 12 x 12 and 24 x 24 available at Balt

GRILLES

TITUS

300RS

Steel Double Deflection Supply Grille, 3/4" Blade Spacing, Front Blades Parallel to Short Dimension

Titus' 300/350 Series supply grilles define the standard for the industry. With high quality and competitive pricing these grilles form the back bone of a standard offering that will meet any application requirements.

NECK SIZE	CFM RANGE	LOCATION
6 x 4	50-125	Balt, MD, VA
6 x 6	60-185	Balt, MD, VA, PA
8 x 4	50-165	Balt, MD, VA
8 x 6	80-250	Balt, MD, VA, PA
8 x 8	110-325	Balt, MD, VA, PA
10 x 4	65-200	Balt, MD, VA
10 x 6	105-300	Balt, MD, VA, PA
10 x 8	140-400	Balt, MD, VA, PA
10 x 10	180-500	Balt, MD, VA, PA
12 x 4	80-250	Balt, MD, VA
12 x 6	125-360	Balt, MD, VA, PA
12 x 8	170-475	Balt, MD, VA, PA
12 x 10	220-580	Balt, MD, VA, PA
12 x 12	265-700	Balt, MD, VA, PA
14 x 4	100-280	MD, VA
14 x 6	145-410	Balt, MD, VA, PA
14 x 8	200-540	Balt, MD, VA, PA
14 x 10	260-685	Balt, MD, VA, PA
14 x 12	310-770	Balt, MD, VA
14 x 14	370-930	Balt, MD, VA
16 x 4	150-360	MD, VA
16 x 6	170-475	Balt, MD, VA
16 x 8	230-610	Balt, MD, VA, PA
16 x 10	295-750	Balt, MD, VA, PA
16 x 12	335-855	Balt, MD, VA
16 x 14	410-1000	MD, VA
16 x 16	485-1150	Balt, MD, VA
18 x 6	190-520	Balt, MD, VA, PA

NECK SIZE	CFM RANGE	LOCATION
18 x 8	265-700	Balt, MD, VA, PA
18 x 10	335-855	Balt, MD, VA, PA
18 x 12	405-1015	Balt, MD, VA, PA
18 x 14	475-1120	MD, VA
18 x 16	545-1275	MD, VA
18 x 18	620-1450	Balt, MD, VA
20 x 4	140-400	MD, VA
20 x 6	220-580	Balt, MD, VA, PA
20 x 8	295-750	Balt, MD, VA, PA
20 x 10	380-940	Balt, MD, VA, PA
20 x 12	450-1100	Balt, MD, VA, PA
24 x 6	265-700	Balt, MD, VA
24 x 8	355-900	Balt, MD, VA, PA
24 x 10	450-1100	Balt, MD, VA, PA
24 x 12	550-1275	Balt, MD, VA, PA
24 x 14	640-1700	MD, VA
24 x 16	700-1800	MD, VA
24 x 18	825-1900	MD, VA
24 x 24	1125-2400	MD, VA
30 x 6	335-855	Balt, MD, VA
30 x 8	450-1050	Balt, MD, VA
30 x 10	550-1275	Balt, MD, VA
30 x 12	700-1550	Balt, MD, VA
30 x 20	1100-2300	MD, VA

NECK SIZE	CFM RANGE	LOCATION
36 x 6	450-950	Balt, MD, VA
36 x 8	550-1275	MD, VA
36 x 10	750-1550	Balt, MD, VA
36 x 12	825-1855	Balt, MD, VA
36 x 18	1265-2700	MD, VA
36 x 24	1700-3400	MD, VA

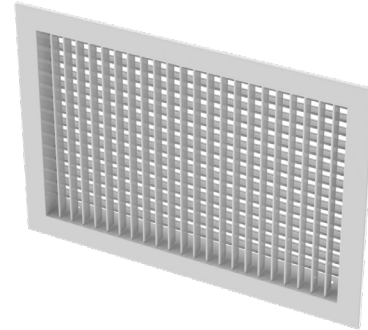

350RL

TITUS

Steel Return Grille, 3/4" Blade Spacing, 35 Degree Deflection, Blades Parallel to Long Dimension

Titus' 300/350 Series return grilles define the standard for the industry. With high quality and competitive pricing these grilles form the back bone of a standard offering that will meet any application requirements.



NECK SIZE	MOUNT	CFM RANGE	LOCATION
6 x 4	Surf/Screw	60	Balt, MD, VA
6 x 6	Surf/Screw	170	Balt, MD, VA, PA
8 x 4	Surf/Screw	125	Balt, MD, VA
8 x 6	Surf/Screw	235	Balt, MD, VA, PA
8 x 8	Surf/Screw	315	Balt, MD, VA, PA
10 x 4	Surf/Screw	200	Balt, MD, VA
10 x 6	Surf/Screw	290	Balt, MD, VA, PA
10 x 8	Surf/Screw	325	Balt, MD, VA, PA
10 x 10	Surf/Screw	460	Balt, MD, VA, PA
10 x 10	Lay - In	460	Balt
12 x 4	Surf/Screw	235	Balt, MD, VA
12 x 6	Surf/Screw	325	Balt, MD, VA, PA
12 x 8	Surf/Screw	455	Balt, MD, VA, PA
12 x 10	Surf/Screw	575	Balt, MD, VA, PA
12 x 12	Surf/Screw	700	Balt, MD, VA, PA
14 x 6	Surf/Screw	385	Balt, MD, VA, PA
14 x 8	Surf/Screw	485	Balt, MD, VA, PA
14 x 10	Surf/Screw	615	Balt, MD, VA, PA
14 x 12	Surf/Screw	700	Balt, MD, VA
14 x 14	Surf/Screw	930	Balt, MD, VA, PA
16 x 6	Surf/Screw	455	Balt, MD, VA
16 x 8	Surf/Screw	575	Balt, MD, VA, PA
16 x 10	Surf/Screw	700	Balt, MD, VA, PA
16 x 12	Surf/Screw	900	Balt, MD, VA, PA
16 x 14	Surf/Screw	1060	Balt, MD, VA
16 x 16	Surf/Screw	1215	Balt, MD, VA, PA
18 x 4	Surf/Screw	360	MD, VA
18 x 6	Surf/Screw	485	Balt, MD, VA
18 x 8	Surf/Screw	700	Balt, MD, VA
18 x 10	Surf/Screw	850	Balt, MD, VA, PA
18 x 12	Surf/Screw	1025	Balt, MD, VA, PA
18 x 14	Surf/Screw	1200	Balt, MD, VA
18 x 16	Surf/Screw	1365	Balt, MD, VA
18 x 18	Surf/Screw	1530	Balt, MD, VA, PA
20 x 6	Surf/Screw	550	Balt, MD, VA
20 x 8	Surf/Screw	690	Balt, MD, VA
20 x 10	Surf/Screw	700	Balt, MD, VA
20 x 12	Surf/Screw	1115	Balt, MD, VA
20 x 14	Surf/Screw	1250	Balt, MD, VA
20 x 16	Surf/Screw	1485	Balt, MD, VA

NECK SIZE	MOUNT	CFM RANGE	LOCATION
20 x 18	Surf/Screw	1700	Balt, MD, VA
20 x 20	Surf/Screw	1800	Balt, MD, VA, PA
22 x 10	Lay - In	1040	Balt, MD, VA, PA
22 x 22	Surf/Screw	2200	Balt, MD, VA, PA
22 x 22	Lay - In	2200	Balt, MD, VA, PA
24 x 6	Surf/Screw	700	Balt, MD, VA, PA
24 x 8	Surf/Screw	900	Balt, MD, VA, PA
24 x 10	Surf/Screw	1115	Balt, MD, VA, PA
24 x 12	Surf/Screw	1345	Balt, MD, VA, PA
24 x 14	Surf/Screw	1550	Balt, MD, VA
24 x 16	Surf/Screw	1715	Balt, MD, VA
24 x 18	Surf/Screw	1980	Balt, MD, VA
24 x 20	Surf/Screw	2180	Balt, MD, VA
24 x 24	Surf/Screw	2400	Balt, MD, VA, PA
30 x 6	Surf/Screw	850	Balt, MD, VA
30 x 8	Surf/Screw	1115	Balt, MD, VA
30 x 10	Surf/Screw	1345	Balt, MD, VA
30 x 12	Surf/Screw	1700	Balt, MD, VA
30 x 16	Surf/Screw	2180	MD, VA
30 x 18	Surf/Screw	2800	MD, VA
30 x 24	Surf/Screw	3250	MD, VA
30 x 30	Surf/Screw	4300	MD, VA
32 x 32	Surf/Screw	4800	MD, VA
36 x 8	Surf/Screw	1345	Balt, MD, VA
36 x 10	Surf/Screw	1700	Balt, MD, VA
36 x 12	Surf/Screw	1980	Balt, MD, VA
36 x 14	Surf/Screw	2250	MD, VA
36 x 16	Surf/Screw	2565	MD, VA
36 x 18	Surf/Screw	2880	Balt, MD, VA
36 x 20	Surf/Screw	3200	MD, VA
36 x 24	Surf/Screw	3775	Balt, MD, VA
36 x 36	Surf/Screw	5600	MD, VA
46 x 22	Lay - In	4400	Balt, MD, VA, PA
48 x 6	Surf/Screw	1700	MD, VA
48 x 8	Surf/Screw	1850	MD, VA
48 x 10	Surf/Screw	2100	MD, VA
48 x 12	Surf/Screw	2400	Balt, MD, VA
48 x 16	Surf/Screw	3100	MD, VA
48 x 18	Surf/Screw	3750	MD, VA
48 x 24	Surf/Screw	5000	Balt, MD, VA, PA

GRILLES

TITUS

EGGCRATE GRILLES

Aluminum Eggcrate Return, Aluminum Border and Grid

Titus Eggcrate grilles have the highest free area of any return grille. These grilles are available with aluminum border and aluminum grid; steel border and aluminum grid; or entirely stainless steel construction. Stocked in ½ x ½ x ½-inch. 45F below has a 45 degree deflection limit ceiling.

MODEL	MOUNT	MATERIAL	MODULE SIZE	NECK SIZE	CFM RANGE	LOCATION
50FA	Surface Mount	Aluminum	-----	6 x 6	200	Balt, MD, VA, PA
50FA	Surface Mount	Aluminum	-----	8 x 8	360	Balt, MD, VA, PA
50FA	Surface Mount	Aluminum	-----	10 x 10	550	Balt, MD, VA, PA
50FA	Surface Mount	Aluminum	-----	12 x 12	775	Balt, MD, VA, PA
50FA	Surface Mount	Aluminum	-----	14 x 14	1000	Balt, MD, VA, PA
50FA	Surface Mount	Aluminum	-----	16 x 16	1300	Balt, MD, VA, PA
50FA	Surface Mount	Aluminum	-----	18 x 18	1600	Balt, MD, VA, PA
50FA	Surface Mount	Aluminum	-----	20 x 20	1975	Balt, PA
50FA	Surface Mount	Aluminum	-----	24 x 12	1450	Balt, MD
50FA	Surface Mount	Aluminum	-----	24 x 24	2750	Balt, MD, VA
50FA	Surface Mount	Aluminum	-----	48 x 24	5090	Balt, PA
50FA	Lay - In	Aluminum	12 x 12	10 x 10	550	PA
50FA	Lay - In	Aluminum	24 x 12	22 x 10	1100	MD, VA, PA
50FA	Lay - In	Aluminum	24 x 24	22 x 22	2350	MD, VA, PA
50FA	Lay - In	Aluminum	48 x 24	46 x 22	4500	MD, VA, PA
45FA	Lay - In	Aluminum	24 x 24	22 x 22	1325	MD

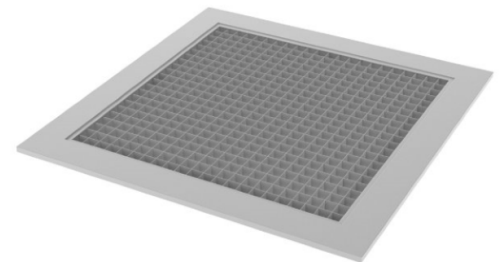

TITUS

350RLF1

Steel Louvered Filter Grille, 35 Degree Deflection, 3/4" Blade Spacing, Blades Parallel to Long Dimension, 1" Filter

Titus' 300/350 Series filter return grilles define the standard for the industry. With high quality and competitive pricing these grilles form the back bone of a standard offering that will meet any application requirements.

MODEL	MOUNT	MODULE SIZE	NECK SIZE	CFM RANGE	LOCATION
350RLF1	Lay - In	24 x 24	20 x 20	1850	Balt, MD, VA, PA
350RLF1	Lay - In	24 x 12	20 x 8	1850	MD, VA





Visit our website at
www.hbproducts.com.

To view inventory for our Baltimore,
Maryland, and Virginia Warehouses,
Login to the website and then
proceed to Member Tools - Inventory.



SCAN ME



Visit our website at
www.johnfscanlan.com.

To view inventory for our
Pennsylvania Warehouse,
Login to the website and
then proceed to Member
Tools - Inventory.



SCAN ME

TITUS

STEEL DAMPERS

Steel Grille and Diffuser Dampers

MODEL	DESCRIPTION	SIZE	LOCATION	MODEL	DESCRIPTION	SIZE	LOCATION
AG-15	Rectangular OBD	6 x 4	Balt, MD, VA	AG-15	Rectangular OBD	24 x 10	Balt, MD, VA, PA
AG-15	Rectangular OBD	6 x 6	Balt, MD, VA, PA	AG-15	Rectangular OBD	24 x 12	Balt, MD, VA, PA
AG-15	Rectangular OBD	8 x 4	Balt, MD, VA	AG-15	Rectangular OBD	24 x 16	Balt, MD, VA
AG-15	Rectangular OBD	8 x 6	Balt, MD, VA, PA	AG-15	Rectangular OBD	24 x 18	Balt, MD, VA
AG-15	Rectangular OBD	8 x 8	Balt, MD, VA, PA	AG-15	Rectangular OBD	24 x 24	Balt, MD, VA, PA
AG-15	Rectangular OBD	10 x 4	Balt, MD, VA	AG-15	Rectangular OBD	30 x 6	Balt, MD, VA
AG-15	Rectangular OBD	10 x 6	Balt, MD, VA, PA	AG-15	Rectangular OBD	30 x 8	Balt, MD, VA
AG-15	Rectangular OBD	10 x 8	Balt, MD, VA, PA	AG-15	Rectangular OBD	30 x 10	Balt, MD, VA
AG-15	Rectangular OBD	10 x 10	Balt, MD, VA, PA	AG-15	Rectangular OBD	30 x 12	Balt, MD, VA
AG-15	Rectangular OBD	12 x 4	Balt, MD, VA	AG-15	Rectangular OBD	36 x 12	Balt
AG-15	Rectangular OBD	12 x 6	Balt, MD, VA, PA	AG-15	Rectangular OBD	36 x 18	Balt
AG-15	Rectangular OBD	12 x 8	Balt, MD, VA, PA	AG-15	Rectangular OBD	36 x 24	Balt
AG-15	Rectangular OBD	12 x 10	Balt, MD, VA, PA	AG-15	Rectangular OBD	46 x 22	Balt
AG-15	Rectangular OBD	12 x 12	Balt, MD, VA, PA	AG-15	Rectangular OBD	48 x 24	Balt
AG-15	Rectangular OBD	14 x 4	Balt, MD, VA	AG-95	Rectangular OBD	6 x 6	Balt, MD, VA, PA
AG-15	Rectangular OBD	14 x 6	Balt, MD, VA, PA	AG-95	Rectangular OBD	9 x 9	Balt, MD, VA, PA
AG-15	Rectangular OBD	14 x 8	Balt, MD, VA, PA	AG-95	Rectangular OBD	12 x 12	Balt, MD, VA, PA
AG-15	Rectangular OBD	14 x 10	Balt, MD, VA, PA	AG-95	Rectangular OBD	15 x 15	Balt, MD, VA, PA
AG-15	Rectangular OBD	14 x 12	Balt, MD, VA	AG-95	Rectangular OBD	18 x 18	Balt, MD, VA, PA
AG-15	Rectangular OBD	14 x 14	Balt, MD, VA, PA	D-100	Round Sliding Duct	6"rd	Balt, MD, VA, PA
AG-15	Rectangular OBD	16 x 6	Balt, MD, VA	D-100	Round Sliding Duct	8"rd	Balt, MD, VA, PA
AG-15	Rectangular OBD	16 x 8	Balt, MD, VA, PA	D-100	Round Sliding Duct	10"rd	Balt, MD, VA, PA
AG-15	Rectangular OBD	16 x 10	Balt, MD, VA, PA	D-100	Round Sliding Duct	12"rd	Balt, MD, VA, PA
AG-15	Rectangular OBD	16 x 12	Balt, MD, VA, PA	D-100	Round Sliding Duct	14"rd	Balt, MD, VA, PA
AG-15	Rectangular OBD	16 x 16	Balt, MD, VA, PA	D-75	Round Neck OBD	6"rd	MD, VA, PA
AG-15	Rectangular OBD	18 x 6	Balt, MD, VA	D-75	Round Neck OBD	8"rd	MD, VA, PA
AG-15	Rectangular OBD	18 x 8	Balt, MD, VA	D-75	Round Neck OBD	10"rd	MD, VA, PA
AG-15	Rectangular OBD	18 x 10	Balt, MD, VA, PA	D-75	Round Nek OBD	12"rd	MD, VA, PA
AG-15	Rectangular OBD	18 x 12	Balt, MD, VA, PA	AG-75	Round Neck OBD	6"rd	MD, VA
AG-15	Rectangular OBD	18 x 18	Balt, MD, VA, PA	AG-75	Round Neck OBD	8"rd	MD, VA
AG-15	Rectangular OBD	22 x 10	Balt, MD, VA, PA	AG-75	Round Neck OBD	10"rd	MD, VA
AG-15	Rectangular OBD	22 x 22	Balt, MD, VA, PA	AG-75	Round Neck OBD	12"rd	MD, VA
AG-15	Rectangular OBD	24 x 6	Balt, MD, VA, PA	AG-75	Round Neck OBD	14"rd	MD, VA
AG-15	Rectangular OBD	24 x 8	Balt, MD, VA, PA	AG-75	Round Neck OBD	15"rd	MD, VA
				AG-75	Round Neck OBD	16"rd	MD, VA

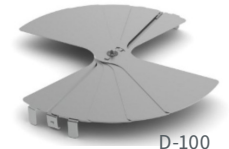
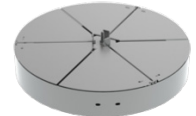

CABLE OPERATED DAMPER YOUNG REGULATOR



MODEL	SIZE / DESCRIPTION	LOCATION
270-275B-Q	Plenum Mount Control Kit (3/8" or 1/4")	MD, VA
270-301B	Ceiling Mount Control Kit w/ 3" Cover Plate (3/8"sq damper shafts)	MD, VA
270-301B-Q	Ceiling Mount Control Kit w/ 3" Cover Plate (5/16" rd or 1/14"sq damper shafts)	MD
270-896B-Q	Ceiling Mount Control Kit w/ 7/8" Cap (3/8" or 1/4")	MD, VA
800AWO	Oval damper, with 1/2" steel shaft 8" & 10"	MD, VA
4011 MOD	Round Motorized Damper 8", 10" & 12"	MD
BCW	Stainless Steel Control Wire - 50ft Roll	MD, VA
03012S	6" Socket Wrench	MD
03012	12" Socket Wrench	MD
YO-WGA48YO	Worm Gear w/ 48" Cable	Balt
YO-RAD-FS4-06	Young Radial Damper 6" RND	Balt
YO-RAD-FS4-08	Young Radial Damper 8" RND	Balt
YO-RAD-FS4-10	Young Radial Damper 10" RND	Balt
YO-RAD-FS4-12	Young Radial Damper 12" RND	Balt

TRIM FRAME

TITUS

Aluminum Rapid Mount Frame/Plaster Frame

Titus mounting frames make installation of grilles, diffusers and other ceiling components in plaster and sheet rock ceilings as simple as inserting them in a standard T-bar type ceiling. For typical applications, the frame has adjustable fastening clips which adapt to a variety of plaster and sheet rock ceiling thicknesses.



MODEL	MATERIAL	SIZE	LOCATION
TRM	Aluminum	12 x 12	Balt, MD, VA, PA
TRM	Aluminum	24 x 12	Balt, MD, VA, PA
TRM	Aluminum	24 x 24	Balt, MD, VA, PA
TRM	Aluminum	48 x 24	Balt, MD, VA, PA

LIGHT SHIELD

DONCO

Curved Light Shield

Designed to support maximum airflow, Curved Insulated Dome provides sound absorption and attenuation to prevent noise from traveling above your ceiling.



MODEL	DESCRIPTION	LOCATION
Curved Insulated Dome	For 24 x 24 Module Lay-In Grilles with 22 x 22 necks	Balt, MD, VA
CLS-L	For 24x24 Module Lay-In Grilles Insulated 1/2" Fiberglass with black facing	Balt, MD, VA
LS - Light Shield	For 24 x 24 module Lay-In Grilles No insulation, Internal Surfaces Painted Flat Black	MD, VA
LSCP - Canopy Light Shield	For 24 x 24 Module Tee Var Lay-In Grilles Insulated 1/2" Fiberglass with black facing	MD, VA

LINEAR DIFFUSER

TITUS

FLOWBAR

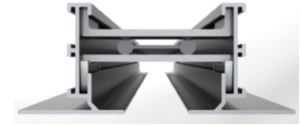

Architectural Linear Diffuser, Aluminum, 1 Slot

Titus FlowBar architectural linear diffuser system maximizes engineering performance without sacrificing aesthetic considerations for the designer. FlowBar's outstanding performance allows higher airflows than conventional linear diffusers.

MODEL	BORDER TYPE	LENGTH	SLOT W	FRAME W	DUCT W	ACCESSORIES / FINISH	CFM PER FT	LOCATION
FL-10	#22- Tape / Spackle	48"	1"	3.25"	2.75"	ECXX end caps, H3 & H5 Clips #84 Black	25-60 per ft	Balt, MD, VA
FL-10	#22- Tape / Spackle	72"	1"	3.25"	2.75"	ECXX end caps, H3 & H5 Clips #84 Black	25-60 per ft	MD, VA
FL-10	#77- Concealed Mount	48"	1"	3"	3.75"	SXX end border, Concealed Mounting Bracket #26 White	25-60 per ft	Balt, MD, VA
FL-10	#77- Concealed Mount	72"	1"	3"	3.75"	SXX end border, Concealed Mounting Bracket #26 White	25-60 per ft	MD, VA
FL-15	#22- Tape / Spackle	48"	1.5"	4.25"	3.75"	ECXX end caps, H3 & H5 Clips #84 Black	30-70 per ft	Balt, MD, VA
FL-15	#22- Tape / Spackle	72"	1.5"	4.25"	3.75"	ECXX end caps, H3 & H5 Clips #84 Black	30-70 per ft	MD, VA
FL-15	#77- Concealed Mount	48"	1.5"	4"	4.75"	SXX end border, Concealed Mounting Bracket #26 White	30-70 per ft	Balt, MD, VA
FL-15	#77- Concealed Mount	72"	1.5"	4"	4.75"	SXX end border, Concealed Mounting Bracket #26 White	30-70 per ft	MD, VA
FL-20	#22- Tape / Spackle	48"	2"	5.25"	4.75"	ECXX end caps, H3 & H5 Clips #84 Black	30-90 per ft	Balt, MD, VA
FL-20	#22- Tape / Spackle	72"	2"	5.25"	4.75"	SXX end border, Concealed Mounting Bracket #26 White	30-90 per ft	MD, VA
FL-20	#77- Concealed Mount	48"	2"	5"	5.75"	SXX end border, Concealed Mounting Bracket #26 White	30-90 per ft	Balt, MD, VA
FL-20	#77- Concealed Mount	72"	2"	5"	5.75"	SXX end border, Concealed Mounting Bracket #26 White	30-90 per ft	MD, VA
FL-25	#22- Tape / Spackle	48"	2.5"	6.25"	5.75"	ECXX end caps, H3 & H5 Clips #84 Black	30-105 per ft	Balt
FL-25	#77- Concealed Mount	48"	2.5"	6"	6.75"	SXX end border, Concealed Mounting Bracket #26 White	30-105 per ft	Balt
FL-30	#22- Tape / Spackle	48"	3"	7.25"	6.75"	ECXX end caps, H3 & H5 Clips #84 Black	30-135 per ft	Balt
FL-30	#77- Concealed Mount	48"	3"	7"	7.75"	SXX end border, Concealed Mounting Bracket #26 White	30-135 per ft	Balt

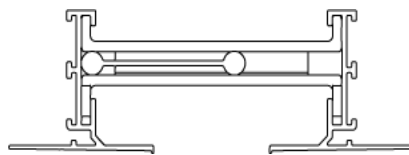

Border 22

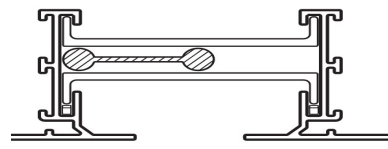

Border 77

TITUS

FLOWBAR ACCESSORIES

ITEM TYPE	MODEL	SIZE	DESCRIPTION	USE WITH	LOCATION
Uninsulated Return Hood/ Light Shield	FBR	48"	Titus FBR is a FlowBar accessory used to create passive return sections and as a light shield.	FL	Balt, MD, VA
Mounting Hardware	H3, H5, SS1, FLHTSK, FLEB, FLEC	-----	H3(5/8") clips / H5 (1/2") clips / Alignment Strips / Field Cut Kits / End Borders / End Caps	FL	Balt, MD, VA

HPL**RAYMON DONCO****Linear Slot Diffuser**

Controllers provide 180 degree throw adjustment and volume control.

MODEL	MOUNT	LENGTH	SLOTS	SLOT WIDTH	DUCT WIDTH	CFM RANGE	LOCATION
HPL75	Surf / Lay-In	47.75"	2	3/4"	4"	80-240	Balt
HPL10	Surf / Lay-In	23.75"	2	1"	4.5"	40-170	Balt
HPL10	Surf / Lay-In	47.75"	2	1"	4.5"	80-340	Balt
HPL10	Surf / Lay-In	71.75"	2	1"	4.5"	120-510	Balt

**ML****TITUS****Linear Slot Diffuser**

Controllers provide 180 degree throw adjustment and volume control.

MODEL	MOUNT	LENGTH	SLOTS	SLOT WIDTH	DUCT WIDTH	CFM RANGE	LOCATION
ML-37	Concealed	48", 60", 72"	1	1/2"	2"	25cfm/ft	MD, VA
ML-37	Concealed	48", 60", 72"	2	1/2"	3.25"	42cfm/ft	MD, VA
ML-38	Concealed	48", 60", 72"	1	3/4"	2.25"	37cfm/ft	MD, VA
ML-38	Concealed	48", 60", 72"	2	3/4"	3.75"	65cfm/ft	MD, VA
ML-38	Concealed	48", 60", 72"	3	3/4"	5.25"	90cfm/ft	MD, VA
ML-38	Concealed	48", 60", 72"	4	3/4"	6.75"	115cfm/ft	MD, VA
ML-38-NT	Lay-In	48"	2	3/4"	3.125"	65cfm/ft	MD, VA
ML-38-NT	Lay-In	48"	3	3/4"	4.625"	90cfm/ft	MD, VA
ML-39	Concealed	48", 60", 72"	1	1"	2.5"	40cfm/ft	MD, VA
ML-39	Concealed	48", 60", 72"	2	1"	4.25"	67cfm/ft	MD, VA, PA
ML-39	Concealed	48", 60", 72"	3	1"	6"	99cfm/ft	MD, VA
ML-39	Concealed	48", 60", 72"	4	1"	7.75"	123cfm/ft	MD, VA

PLENUMS**RAYMON DONCO****Tall 9" Plenum**

24 gauge galvanized steel. Oval adapter plates 6"-12" available to change inlet size at Baltimore.



MODEL	MATCHING AIR DEVICE USE	LENGTH	NECK SIZES	PLENUM WIDTH	LOCATION
SDP4-06	HPL1042, HPL7542, FL-1077, FL-1577	48"	6" inlet	4.25"	Balt
SDP4-08	HPL1042, HPL7542, FL-1077, FL-1577	48"	8" inlet	4.25"	Balt, MD
SDP4-10	HPL1042, HPL7542, FL-1077, FL-1577	48"	10" inlet	4.25"	Balt, MD
SDP4-12	HPL1042, HPL7542, FL-1077, FL-1577	48"	12" inlet	4.25"	Balt
SDP41-FL1022-10	FL10 border 22	48"	10" inlet	2.75"	MD
SDP41-FL1022-08	FL10 border 22	48"	8" inlet	2.75"	Balt, MD
SDP41-FL1522-08	FL15 border 22	48"	8" inlet	3.75"	Balt
SDP41-FL2022-08	FL20 border 22	48"	8" inlet	4.75"	Balt
SDP41-FL2522-08	FL25 border 22	48"	8" inlet	5.75"	Balt
SDP41-FL3022-08	FL30 border 22	48"	8" inlet	6.75"	Balt

LINEAR DIFFUSER

TITUS/DONCO

TBDI-80 / DCDT



Adjustable, Gasket-Tipped Blade Plenum Slot Diffuser

Titus TBD series plenum slot diffusers provide flexibility, great performance and ease of installation. Their adjustability and streamlined appearance make them the industry standard for plenum slot diffusers. The TBD-80 works with many types of ceiling systems - plaster, splined, regressed, and standard lay-in.

MODEL	MOUNT	LENGTH	SLOTS	SLOT WIDTH	NECK SIZE	PLENUM HEIGHT	DIFFUSER WIDTH	CFM RANGE	ACCESSORIES	LOCATION
TBDI-80	Lay - In*	24"	2	1"	6"	8"	4"	60-130	Center Tee	MD, VA, PA
TBDI-80	Lay - In*	24"	2	1"	8"	8"	4"	75-160	Center Tee	MD, VA, PA
TBDI-80	Lay - In*	48"	2	1"	8"	8"	4"	90-240	Center Tee	MD, VA, PA
TBDI-80	Lay - In*	48"	2	1"	10"	8"	4"	120-270	Center Tee	MD, VA, PA
TBDI-80-NT	Lay - In	24"	2	1"	6"	8"	4.5"	60-130	Cross Notch (no tee)	MD, VA
TBDI-80-NT	Lay - In	24"	2	1"	8"	8"	4.5"	75-160	Cross Notch (no tee)	MD, VA
TBDI-80-NT	Lay - In	48"	2	1"	8"	8"	4.5"	90-240	Cross Notch (no tee)	MD, VA
TBDI-80-NT	Lay - In	48"	2	1"	10"	8"	4.5"	120-270	Cross Notch (no tee)	MD, VA

TITUS

TBDI-30

Adjustable Plenum Slot Diffuser

Titus TBD series plenum slot diffusers provide flexibility, great performance and ease of installation. Their adjustability and streamlined appearance make them the industry standard for plenum slot diffusers. The TBD-30 projects a tight blanket of air across the ceiling from minimum to maximum airflow in the horizontal position.

MODEL	MOUNT	LENGTH	SLOTS	SLOT WIDTH	NECK SIZE	PLENUM HEIGHT	DIFFUSER WIDTH	CFM RANGE	ACCESSORIES	LOCATION
TBDI-30	Lay - In*	24"	2	3/4"	8"	11"	4"	50-135	Center Tee	Balt
TBDI-30	Lay - In*	48"	2	3/4"	8"	11"	4"	90-210	Center Tee	Balt
TBDI-30	Lay - In*	48"	2	3/4"	10"	11"	4"	90-240	Center Tee	Balt

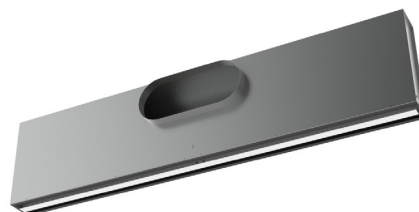



J-SLOT/ J-SLOT-NT

DONCO

Plenum Slot Diffuser

Donco J-Slot is excellent for variable volume systems. The J-Slot provides excellent coanda. Their lower flange provides tile support. The exposed surfaces are painted white.

MODEL	MOUNT	LENGTH	SLOTS	SLOT WIDTH	NECK SIZE	PLENUM HEIGHT	DIFFUSER WIDTH	CFM RANGE	ACCESSORIES	LOCATION
J-22(NT)	Lay - In	24"	2	1"	6"	12.45"	4.125"	35-230	Center Tee	MD
J-22(NT)	Lay - In	24"	2	1"	8"	12.45"	4.125"	40-250	Center Tee	MD
J-22	Lay - In	48"	2	1"	8"	12.45"	4.125"	80-380	Cross Notch	MD
J-22	Lay - In	48"	2	1"	10"	14"	4.125"	100-400	Cross Notch	MD

PLASTER FRAMES

TITUS

Linear Mounting Frames

Titus mounting frames make installation of grilles, diffusers and other ceiling components in plaster and sheet rock ceilings as simple as inserting them in a standard T-bar type ceiling. For typical applications, the frame has adjustable fastening clips which adapt to a variety of plaster and sheet rock ceiling thicknesses.

MODEL	MATERIAL	LENGTH	SLOTS	SLOT WIDTH	CEILING OPENING	LOCATION
PFTBD2423/4	Aluminum	24"	2	3/4"	24 1/2" x 4 1/4"	Balt
PFTBD2421	Aluminum	24"	2	1"	24 1/2" x 4 3/4"	Balt, MD, VA
PFTBD4823/4	Aluminum	48"	2	3/4"	48 1/2" x 4 1/4"	Balt
PFTBD4821	Aluminum	48"	2	1"	48 1/2" x 4 3/4"	Balt, MD, VA
PFTBD4821 1/2	Aluminum	48"	2	1 1/2"	48 1/2" x 5 3/4"	Balt



METALAIRE

5500S-6 (TDC)

Steel Louvered Face Diffuser

Steel 4 way blow directional diffuser with easy to remove cores - no tools required. 5500 series deflector blades include a horizontal lip, making this diffuser an excellent choice for high induction applications.

MODEL	MOUNT	MODULE SIZE	NECK SIZE	CFM RANGE	THROW	LOCATION
MA-5500S6-0606	Lay - In	24 x 24	6 x 6	50-185	4-34	Balt
MA-5500S6-0909	Lay - In	24 x 24	9 x 9	113-349	6-30	Balt
MA-5500S6-1212	Lay - In	24 x 24	12 x 12	200-560	9-29	Balt
MA-5500S6-1515	Lay - In	24 x 24	15 x 15	313-812	12-30	Balt
MA-5500S6-1818	Lay - In	24 x 24	18 x 18	450-1225	16-32	Balt

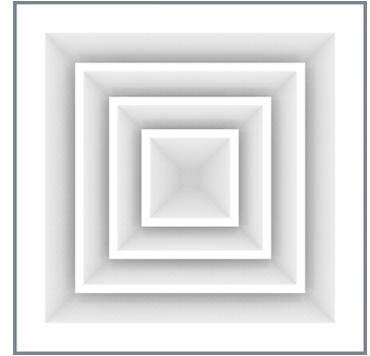

METALAIRE

5700-6 (TMS)

Square Louvered Faced Diffuser

Steel 2-Cone square face diffuser with round neck. The 5700 provides a tight horizontal 360° discharge pattern for superior induction and occupant comfort. Optional BDS damper.

MODEL	MOUNT	MODULE SIZE	NECK SIZE	CFM RANGE	THROW	LOCATION
MA-57006-06-12	Lay - In	12 x 12	6	80-211	6-9	Balt
MA-57006-08-12	Lay - In	12 x 12	8	140-338	8-13	Balt
MA-57006-06-24	Lay - In	24 x 24	6	80-298	7-15	Balt
MA-57006-08-24	Lay - In	24 x 24	8	140-490	10-18	Balt
MA-57006-10-24	Lay - In	24 x 24	10	220-655	12-21	Balt
MA-57006-12-24	Lay - In	24 x 24	12	315-863	15-25	Balt
MA-57006-14-24	Lay - In	24 x 24	14	430-1131	17-28	Balt

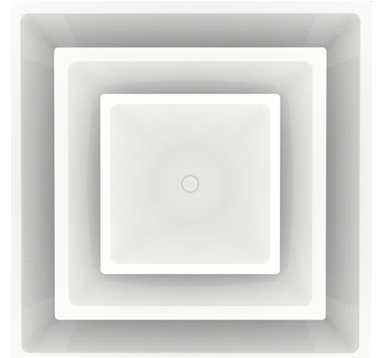

METALAIRE

5700A-6 (TMSA)

Square Louvered Faced Diffuser

Steel 2-Cone square face diffuser with round neck. The 5700A can adjust from horizontal to vertical discharge.

MODEL	MOUNT	MODULE SIZE	NECK SIZE	CFM RANGE	THROW	LOCATION
MA-5700A6-06-24	Lay - In	24 x 24	6	80-298	7-15	Balt
MA-5700A6-08-24	Lay - In	24 x 24	8	140-490	10-18	Balt
MA-5700A6-10-24	Lay - In	24 x 24	10	220-655	12-21	Balt
MA-5700A6-12-24	Lay - In	24 x 24	12	315-863	15-25	Balt
MA-5700A6-14-24	Lay - In	24 x 24	14	430-1131	17-28	Balt

METALAIRE

5750-6 (OMNI)

Architectural Square Plaque Diffuser

Steel square panel-face ceiling diffuser. The 5750 provides a tight 360° discharge pattern for superior induction and occupant comfort.

MODEL	MOUNT	MODULE SIZE	NECK SIZE	CFM RANGE	THROW	LOCATION
MA-57506-06-24	Lay - In	24 x 24	6	80-267	5-12	Balt
MA-57506-08-24	Lay - In	24 x 24	8	140-373	6-13	Balt
MA-57506-10-24	Lay - In	24 x 24	10	220-490	8-16	Balt
MA-57506-12-24	Lay - In	24 x 24	12	315-705	10-19	Balt
MA-57506-14-24	Lay - In	24 x 24	14	430-855	11-21	Balt

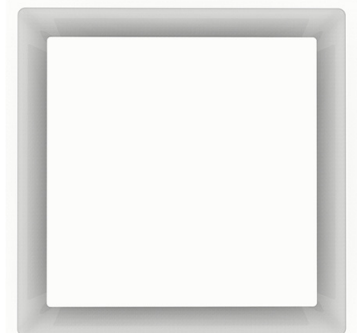

7500-6 (PAS)

METALAIRE

Perforated Face Ceiling Diffuser with Face Mounted Pattern Controllers

Steel supply/return perforated ceiling diffusers have a round neck and face mounted adjustable pattern controllers. Pattern controllers are adjustable from vertical to horizontal discharge patterns. Optional BDS damper.

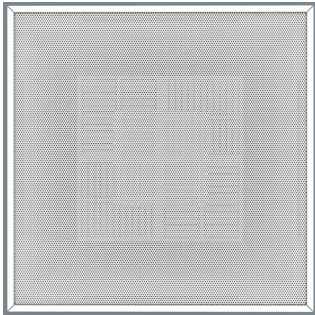

MODEL	MOUNT	MODULE SIZE	NECK SIZE	CFM RANGE	THROW	LOCATION
MA-75006-06-12	Lay - In	12 x 12	6	60-188	4-8	Balt
MA-75006-06-24	Lay - In	24 x 24	6	60-188	4-8	Balt
MA-75006-08-24	Lay - In	24 x 24	8	105-280	5-10	Balt
MA-75006-10-24	Lay - In	24 x 24	10	165-402	6-12	Balt
MA-75006-12-24	Lay - In	24 x 24	12	235-539	7-14	Balt
MA-75006-14-24	Lay - In	24 x 24	14	320-687	9-15	Balt
MA-75006-16-24	Lay - In	24 x 24	16	420-859	10-17	Balt

7500R-6 (PAR)

METALAIRE

Perforated Face Ceiling Diffuser

Steel supply/return perforated ceiling diffusers have a round neck. Optional BDS damper.

MODEL	MOUNT	MODULE SIZE	NECK SIZE	CFM RANGE	THROW	LOCATION
MA-7500R6-06-24	Lay - In	24 x 24	6	60-268	-	Balt
MA-7500R6-08-24	Lay - In	24 x 24	8	105-385	-	Balt
MA-7500R6-10-24	Lay - In	24 x 24	10	165-600	-	Balt
MA-7500R6-12-24	Lay - In	24 x 24	12	235-825	-	Balt
MA-7500R6-14-24	Lay - In	24 x 24	14	320-997	-	Balt
MA-7500R6-16-24	Lay - In	24 x 24	16	420-1208	-	Balt
MA-7500R6-18-24	Lay - In	24 x 24	18	520-1400	-	Balt
MA-7500R6-2210-2412	Lay - In	24 x 12	22 x 10	420-1208	-	Balt
MA-7500R6-2222-2424	Lay - In	24 x 24	22 x 22	942-2092	-	

7600-6 (PCS)

METALAIRE

Perforated Face Ceiling Diffuser with Curved Blade Pattern Controller

Steel supply or return perforated ceiling diffuser. Curved blade pattern controllers are neck mounted and are adjustable from vertical to horizontal air patterns. Optional BDS damper.



MODEL	MOUNT	MODULE SIZE	NECK SIZE	CFM RANGE	THROW	LOCATION
MA-76006-06-24	Lay - In	24 x 24	6	60-195	5-9	Balt
MA-76006-08-24	Lay - In	24 x 24	8	105-333	6-12	Balt
MA-76006-10-24	Lay - In	24 x 24	10	165-457	8-13	Balt
MA-76006-12-24	Lay - In	24 x 24	12	235-610	9-16	Balt
MA-76006-14-24	Lay - In	24 x 24	14	320-776	11-17	Balt
MA-76006-16-24	Lay - In	24 x 24	16	420-975	12-19	Balt

SPRTB (PXP)

METALAIRE

Perforated Screen for Non-Ducted Plenum

The series PRTB and SPRTB(Steel) are an economical choice for non-duct plenum return applications and are shipped without pattern controllers. The PRTB is constructed from aluminum for corrosion resistance. The SPRTB is constructed from steel for durability. Unit can be used in surface mounting applications by adding optional T-bar plaster frame (TBPf).

MODEL	MOUNT	MODULE SIZE	CFM RANGE	LOCATION
MA-SPRTB-24	SURFACE	24 x 24	735-1981	Balt

METALAIRE

METALAIRE

BDS

BDS Steel Butterfly Damper

The model BDS is a steel Butterfly Damper with Adjustable Blades.

MODEL	NECK SIZE	LOCATION
MA-BDS-06	6	Balt
MA-BDS-08	8	Balt
MA-BDS-10	10	Balt
MA-BDS-12	12	Balt
MA-BDS-14	14	Balt
MA-BDS-16	16	Balt



METALAIRE

STBPF (TRM)

T-Bar Plaster Frame

Plaster frame for T-bar frame style ceiling diffuser into plaster or gypsum type ceilings

MODEL	MOUNT	MODULE SIZE	LOCATION
MA-STBPF-1212	Lay - In	12 x 12	Balt
MA-STBPF-2412	Lay - In	24 x 12	Balt
MA-STBPF-2424	Lay - In	24 x 24	Balt
MA-STBPF-4824	Lay - In	48 x 24	Balt



METALAIRE

3000-1 (TMRA)

Adjustable Three Cone Round Diffuser

Series 3000 Round Adjustable Diffusers incorporate a high induction design to efficiently handle large volumes of air at high cooling temperature differentials and yet maintain low room air motion.

MODEL	MOUNT	MODULE SIZE	NECK SIZE	CFM RANGE	LOCATION
MA-30001-06	Surface Mount	13.875"	6" rd	75-160	Balt
MA-30001-08	Surface Mount	18.625"	8" rd	130-265	Balt
MA-30001-10	Surface Mount	22.125"	10" rd	200-415	Balt
MA-30001-12	Surface Mount	27"	12" rd	290-500	Balt

METALAIRE

PHPSI (TBDI-80)

Plenum Slot Diffuser - Adjustable Pattern Controller

Steel supply/return plenum slot diffusers with heavy duty extruded aluminum single blade pattern controllers, and gasket for horizontal discharge pattern. Field adjustable pattern controllers allow the throw to be changed from vertical to horizontal.

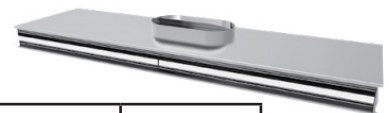

MODEL	MOUNT	LENGTH	SLOTS	SLOT WIDTH	NECK SIZE	CFM RANGE	THROW	LOCATION
MA-PHPSI6-08-24/2/1	Lay - In	24	2	1"	8	20-180	1-21	Balt
MA-PHPSI6-08-48/2/1	Lay - In	48	2	1"	8	40-336	1-29	Balt
MA-PHPSI6-10-48/2/1	Lay - In	48	2	1"	10	40-336	1-29	Balt
MA-PHPSI6-12-48/2/1	Lay - In	48	2	1.5"	12	40-450	2-33	Balt

CC5TB (50F)

METALAIRE

Eggcrate Grille

Aluminum cubed core return and exhaust grilles are designed to provide low pressure drops and low sound levels.

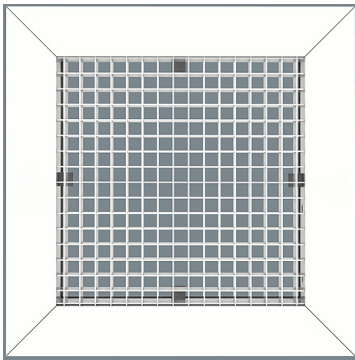

MODEL	MOUNT	MODULE SIZE	NECK SIZE	CFM RANGE	LOCATION
MA-CC5TB-1010-1212	Lay - In	12 x 12	10 x 10	131-653	Balt
MA-CC5TB-2210-2412	Lay - In	24 x 12	22 x 10	287-1338	Balt
MA-CC5TB-2222-2424	Lay - In	24 x 24	22 x 22	642-2728	Balt
MA-CC5TB-4622-4824	Lay - In	48 x 24	46 x 22	1410-5112	Balt

DGDF (T700L)

METALAIRE

Aluminum Door Grilles

Series DG extruded aluminum door grilles are designed to transfer air through doors or walls. The DG series include "V" shaped louvers providing a sight-proof return or exhaust grille regardless of the viewing angle, as well as double flange frame.

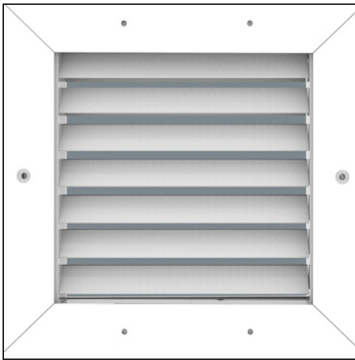

MODEL	MOUNT	NECK SIZE	CFM RANGE	LOCATION
MA-DGDF-1212	Surface	12 x 12	200-433	Balt
MA-DGDF-1812	Surface	18 x 12	300-563	Balt
MA-DGDF-1818	Surface	18 x 18	450-750	Balt
MA-DGDF-2412	Surface	24 x 12	400-700	Balt
MA-DGDF-2424	Surface	24 x 24	800-1100	Balt

RHF-1 (350FLF1)

METALAIRE

Aluminum Filter Return Grilles

Model RH return grilles combine the advantages of corrosion resistant construction and durability with an attractive design, excellent performance, and competitive pricing.

MODEL	MOUNT	MODULE SIZE	CFM RANGE	LOCATION
MA-RHF1-1212	SURFACE	12 x 12	177-494	Balt
MA-RHF1-1818	SURFACE	18 x 18	415-1002	Balt
MA-RHF1-2020	SURFACE	20 x 20	515-1235	Balt
MA-RHF1-2412	SURFACE	24 x 12	365-911	Balt
MA-RHF1-2424	SURFACE	24 x 24	752-1653	Balt

RH-TB (350FL)

METALAIRE

Roll Formed Aluminum Return Air Grilles

Model RH return grilles combine the advantages of corrosion resistant construction and durability with an attractive design, excellent performance, and competitive pricing.

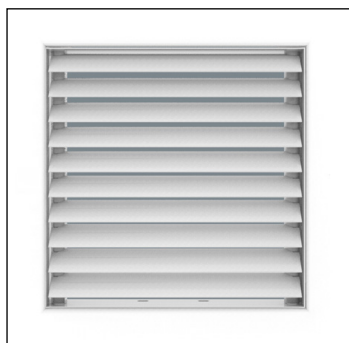

MODEL	MOUNT	MODULE SIZE	NECK SIZE	CFM RANGE	LOCATION
MA-RH-TB2210-2412	Lay - In	24 x 12	22 x 10	300-750	Balt
MA-RH-TB2222-2424	Lay - In	24 x 24	22 x 22	672-1905	Balt
MA-RH-TB4622-4824	Lay - In	48 x 24	46 x 22	1200-2850	Balt

Roll Formed Aluminum Return Air Grilles

Model RH return grilles combine the advantages of corrosion resistant construction and durability with an attractive design, excellent performance, and competitive pricing.

MODEL	MOUNT	NECK SIZE	CFM RANGE	LOCATION
MA-RH-0604	Surface	6 x 4	40-230	Balt
MA-RH-0606	Surface	6 x 6	50-265	Balt
MA-RH-0804	Surface	8 x 4	46-248	Balt
MA-RH-0806	Surface	8 x 6	67-317	Balt
MA-RH-0808	Surface	8 x 8	89-415	Balt
MA-RH-1004	Surface	10 x 4	50-265	Balt
MA-RH-1006	Surface	10 x 6	83-389	Balt
MA-RH-1008	Surface	10 x 8	100-433	Balt
MA-RH-1010	Surface	10 x 10	139-579	Balt
MA-RH-1204	Surface	12 x 4	67-317	Balt
MA-RH-1206	Surface	12 x 6	100-450	Balt
MA-RH-1208	Surface	12 x 8	133-555	Balt
MA-RH-1210	Surface	12 x 10	167-667	Balt
MA-RH-1212	Surface	12 x 12	200-767	Balt
MA-RH-1404	Surface	14 x 4	67-317	Balt
MA-RH-1406	Surface	14 x 6	100-450	Balt
MA-RH-1408	Surface	14 x 8	139-579	Balt
MA-RH-1410	Surface	14 x 10	167-667	Balt
MA-RH-1412	Surface	14 x 12	233-856	Balt
MA-RH-1414	Surface	14 x 14	272-953	Balt
MA-RH-1606	Surface	16 x 6	133-555	Balt
MA-RH-1608	Surface	16 x 8	145-578	Balt
MA-RH-1610	Surface	16 x 10	200-767	Balt
MA-RH-1612	Surface	16 x 12	250-917	Balt
MA-RH-1614	Surface	16 x 14	300-1050	Balt
MA-RH-1616	Surface	16 x 16	350-1167	Balt
MA-RH-1806	Surface	18 x 6	139-579	Balt
MA-RH-1808	Surface	18 x 8	200-767	Balt
MA-RH-1810	Surface	18 x 10	250-917	Balt
MA-RH-1812	Surface	18 x 12	300-1050	Balt
MA-RH-1814	Surface	18 x 14	350-1167	Balt
MA-RH-1816	Surface	18 x 16	400-1267	Balt
MA-RH-1818	Surface	18 x 18	450-1425	Balt
MA-RH-2006	Surface	20 x 6	167-667	Balt
MA-RH-2008	Surface	20 x 8	200-800	Balt
MA-RH-2010	Surface	20 x 10	272-943	Balt
MA-RH-2012	Surface	20 x 12	333-1111	Balt

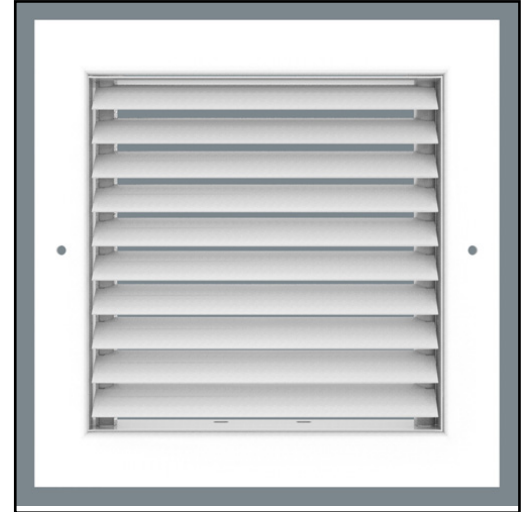

RH (350FL)

METALAIRE

Roll Formed Aluminum Return Air Grilles

Model RH return grilles combine the advantages of corrosion resistant construction and durability with an attractive design, excellent performance, and competitive pricing.

MODEL	MOUNT	NECK SIZE	CFM RANGE	LOCATION
MA-RH-2014	Surface	20 x 14	350-1167	Balt
MA-RH-2016	Surface	20 x 16	400-1267	Balt
MA-RH-2018	Surface	20 x 18	500-1500	Balt
MA-RH-2020	Surface	20 x 20	556-1667	Balt
MA-RH-2406	Surface	24 x 6	200-767	Balt
MA-RH-2408	Surface	24 x 8	250-917	Balt
MA-RH-2410	Surface	24 x 10	333-1111	Balt
MA-RH-2412	Surface	24 x 12	400-1267	Balt
MA-RH-2414	Surface	24 x 14	450-1425	Balt
MA-RH-2416	Surface	24 x 16	500-1500	Balt
MA-RH-2418	Surface	24 x 18	600-1700	Balt
MA-RH-2420	Surface	24 x 20	650-1853	Balt
MA-RH-2424	Surface	24 x 24	700-1983	Balt
MA-RH-3006	Surface	30 x 6	250-917	Balt
MA-RH-3008	Surface	30 x 8	333-1111	Balt
MA-RH-3010	Surface	30 x 10	400-1267	Balt
MA-RH-3012	Surface	30 x 12	500-1500	Balt
MA-RH-3014	Surface	30 x 14	556-1667	Balt
MA-RH-3016	Surface	30 x 16	600-1700	Balt
MA-RH-3018	Surface	30 x 18	750-2000	Balt
MA-RH-3020	Surface	30 x 20	833-2222	Balt
MA-RH-3024	Surface	30 x 24	1000-2500	Balt
MA-RH-3030	Surface	30 x 30	1200-2850	Balt
MA-RH-3606	Surface	36 x 6	300-1050	Balt
MA-RH-3608	Surface	36 x 8	400-1267	Balt
MA-RH-3610	Surface	36 x 10	500-1500	Balt
MA-RH-3612	Surface	36 x 12	600-1700	Balt
MA-RH-3614	Surface	36 x 14	700-1983	Balt
MA-RH-3616	Surface	36 x 16	800-2133	Balt
MA-RH-3618	Surface	36 x 18	900-2400	Balt
MA-RH-3620	Surface	36 x 20	1000-2500	Balt
MA-RH-3624	Surface	36 x 24	1200-2850	Balt
MA-RH-3630	Surface	36 x 30	1400-3325	Balt
MA-RH-3636	Surface	36 x 36	1600-3467	Balt
MA-RH-4824	Surface	48 x 24	1600-3467	Balt

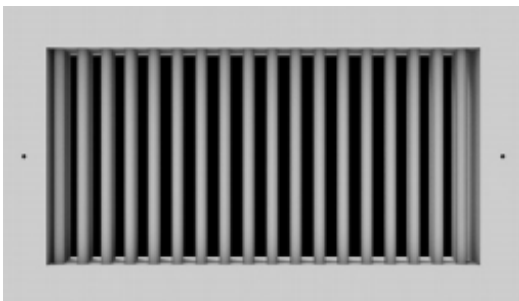

METALAIRE

V4004D-1 (300FS)

Aluminum Double Deflection Supply Register

Double deflection supply register with screw holes and damper

MODEL	MOUNT	NECK SIZE	CFM RANGE	THROW	LOCATION
MA-V4004D1-0604	Surface	6 x 4	24-84	2-17	Balt
MA-V4004D1-0606	Surface	6 x 6	38-133	4-30	Balt
MA-V4004D1-0804	Surface	8 x 4	24-84	2-17	Balt
MA-V4004D1-0806	Surface	8 x 6	38-133	4-30	Balt
MA-V4004D1-0808	Surface	8 x 8	73-256	3-29	Balt
MA-V4004D1-1004	Surface	10 x 4	38-133	4-15	Balt
MA-V4004D1-1006	Surface	10 x 6	73-256	3-29	Balt
MA-V4004D1-1008	Surface	10 x 8	93-326	3-33	Balt
MA-V4004D1-1010	Surface	10 x 10	118-414	4-37	Balt
MA-V4004D1-1204	Surface	12 x 4	73-256	3-29	Balt
MA-V4004D1-1206	Surface	12 x 6	82-287	3-31	Balt
MA-V4004D1-1208	Surface	12 x 8	118-414	4-37	Balt
MA-V4004D1-1210	Surface	12 x 10	145-509	4-41	Balt
MA-V4004D1-1212	Surface	12 x 12	176-615	8-64	Balt
MA-V4004D1-1404	Surface	14 x 4	82-287	3-31	Balt
MA-V4004D1-1406	Surface	14 x 6	93-326	3-33	Balt
MA-V4004D1-1408	Surface	14 x 8	134-468	4-41	Balt
MA-V4004D1-1410	Surface	14 x 10	170-595	4-45	Balt
MA-V4004D1-1412	Surface	14 x 12	213-746	5-50	Balt
MA-V4004D1-1414	Surface	14 x 14	244-853	5-54	Balt
MA-V4004D1-1606	Surface	16 x 6	118-414	4-37	Balt
MA-V4004D1-1608	Surface	16 x 8	153-536	4-43	Balt
MA-V4004D1-1610	Surface	16 x 10	213-746	5-50	Balt
MA-V4004D1-1612	Surface	16 x 12	257-900	5-55	Balt
MA-V4004D1-1614	Surface	16 x 14	295-1031	6-59	Balt
MA-V4004D1-1806	Surface	18 x 6	134-468	4-41	Balt
MA-V4004D1-1808	Surface	18 x 8	176-615	8-64	Balt
MA-V4004D1-1810	Surface	18 x 10	213-746	5-50	Balt
MA-V4004D1-1812	Surface	18 x 12	257-900	5-55	Balt
MA-V4004D1-1814	Surface	18 x 14	323-1131	6-62	Balt
MA-V4004D1-2006	Surface	20 x 6	145-509	4-41	Balt
MA-V4004D1-2008	Surface	20 x 8	213-746	5-50	Balt
MA-V4004D1-2010	Surface	20 x 10	273-956	6-57	Balt
MA-V4004D1-2012	Surface	20 x 12	323-1131	6-62	Balt
MA-V4004D1-2014	Surface	20 x 14	364-1272	6-66	Balt
MA-V4004D1-2406	Surface	24 x 6	176-615	8-64	Balt

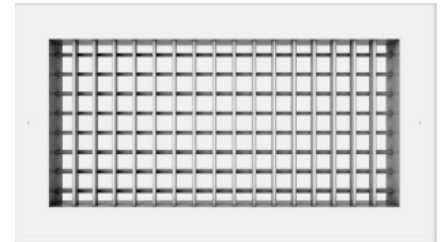

V4004D-1 (300FS)

METALAIRE

Aluminum Double Deflection Supply Register Continued

Double deflection supply register with screw holes and damper

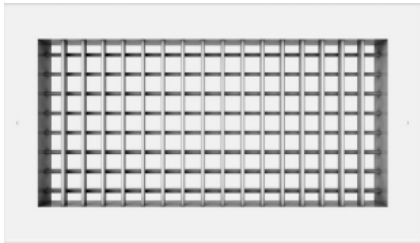

MODEL	MOUNT	NECK SIZE	CFM RANGE	THROW	LOCATION
MA-V4004D1-2408	Surface	24 x 8	257-900	5-55	Balt
MA-V4004D1-2410	Surface	24 x 10	295-1031	6-59	Balt
MA-V4004D1-2412	Surface	24 x 12	364-1272	6-66	Balt
MA-V4004D1-2414	Surface	24 x 14	456-2386	7-88	Balt
MA-V4004D1-3006	Surface	30 x 6	213-746	5-50	Balt
MA-V4004D1-3008	Surface	30 x 8	295-1031	6-59	Balt
MA-V4004D1-3010	Surface	30 x 10	414-1447	7-70	Balt
MA-V4004D1-3012	Surface	30 x 12	456-2386	7-88	Balt
MA-V4004D1-3014	Surface	30 x 14	-----	-----	Balt
MA-V4004D1-3606	Surface	36 x 6	257-900	5-55	Balt
MA-V4004D1-3608	Surface	36 x 8	364-1272	6-66	Balt
MA-V4004D1-3610	Surface	36 x 10	456-2386	7-88	Balt
MA-V4004D1-3612	Surface	36 x 12	550-2676	8-95	Balt
MA-V4004D1-3614	Surface	36 x 14	626-2957	8-100	Balt

VM1 (301FS)

METALAIRE

Aluminum Stamped Frame Supply Grilles

Single deflection - multi-shutter damper grille.



MODEL	MOUNT	MODULE SIZE	CFM RANGE	LOCATION
MA-VM1-0804	Surface	8 x 4	33-164	Balt
MA-VM1-0806	Surface	8 x 6	53-248	Balt
MA-VM1-1004	Surface	10 x 4	43-205	Balt
MA-VM1-1006	Surface	10 x 6	69-307	Balt
MA-VM1-1008	Surface	10 x 8	93-404	Balt
MA-VM1-1204	Surface	12 x 4	53-248	Balt
MA-VM1-1206	Surface	12 x 6	82-473	Balt
MA-VM1-1208	Surface	12 x 8	113-473	Balt
MA-VM1-1404	Surface	14 x 4	60-270	Balt
MA-VM1-1406	Surface	14 x 6	97-412	Balt
MA-VM1-1408	Surface	14 x 8	130-536	Balt

TITUS

T3SQ-4

Thermal Variable Air Volume Diffuser

The T3SQ-4 works in heating/cooling applications. The curvature of the backpan works with the formed edges of the face panel to deliver a tight horizontal air pattern without excessive noise or pressure drop over the full range of operation. As the volume of air is decreased by the control disc, the velocity of air is increased, thus maintaining the longest throw and best entrainment. This ensures superior performance at all damper positions.

MODEL	MOUNT	MATERIAL	MODULE SIZE	NECK SIZE	CFM RANGE	LOCATION
T3SQ-4	Lay - In	Steel	24 x 24	8"	140-350	MD
T3SQ-4	Lay - In	Steel	24 x 24	10"	220-490	MD

TITUS

ACCESSORIES

NAME	DESCRIPTION	SIZE	LOCATION
Trim Frame	Aluminum	24 x 24	Balt, MD, VA, PA
Relief Ring	8"	6"	MD
Relief Ring	10"	8"	MD

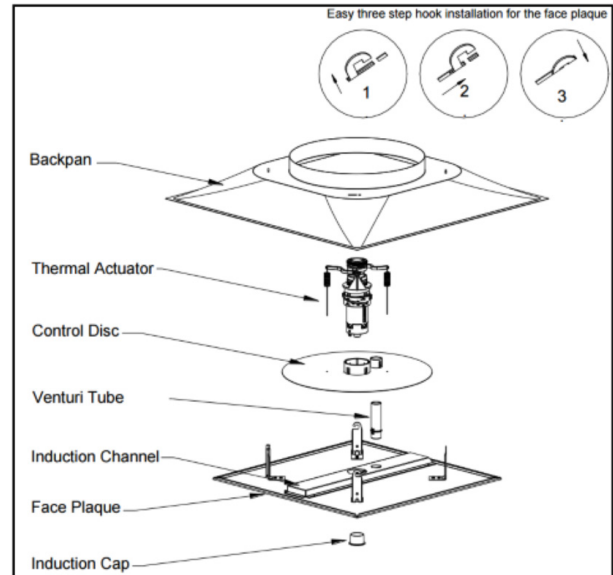
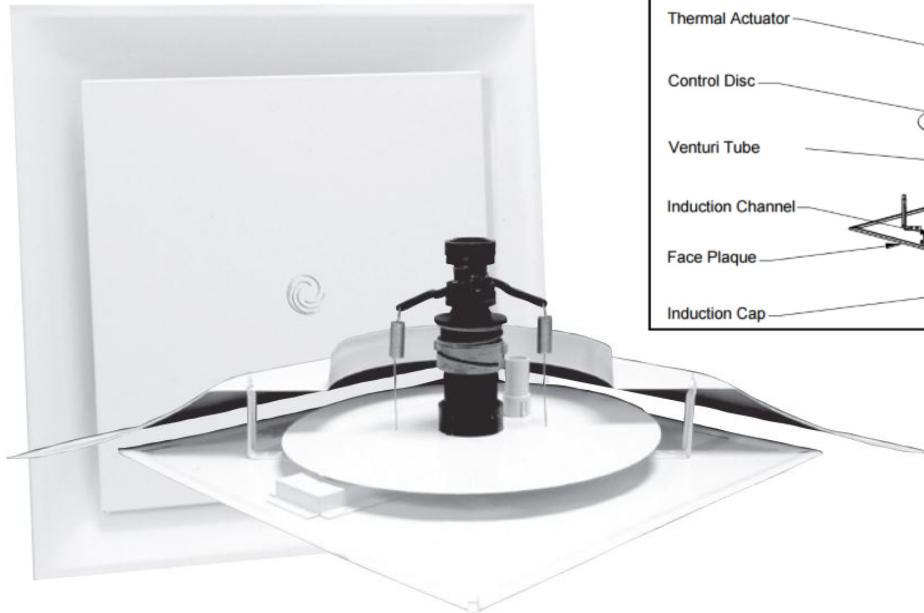

ESV

TITUS

Digital Single Duct Terminal

Single Duct terminals are the fundamental building blocks for Variable Air Volume (VAV) systems. Their primary function is to regulate airflow to a zone, in response to zone temperature requirements. The Titus ESV is unique as it incorporates many design features that increase performance, decrease service and installation costs, and offer increased value, over and above this basic function.

Water Coil Description: Aluminum plate fins, 10 per square inch, slip and drive connection
 Pipe connections: 1 Row, box size 4 thru 8 = 1/2" O.D. male solder
 All other coils (1 and 2 row) = 7/8" O.D. male solder

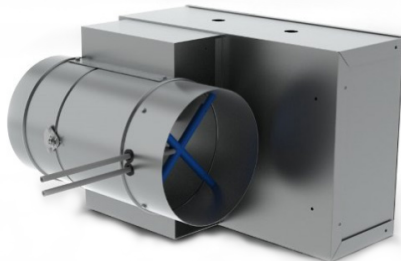

MODEL	INLET SIZE	OUTLET SIZE (W X H X L)	LOCATION
ESV	6"rd	12" x 8" x 15.5"	Balt, MD, VA, PA
ESV	8"rd	12" x 10" x 15.5"	Balt, MD, VA, PA
ESV	10"rd	14" x 12.5" x 15.5"	Balt, MD, VA, PA
ESV	12"rd	16" x 15" x 15.5"	Balt, MD, VA, PA
ESV	14"rd	20" x 17.5" x 15.5"	Balt, MD
ESV	16"rd	24" x 18" x 15.5"	Balt, PA
ESV-40	24" x 16"	38" x 18" x 15"	Balt
ECV	6"rd	6"rd	Balt
ECV	8"rd	8"rd	Balt
ECV	10"rd	10"rd	Balt
ECV	12"rd	12"rd	Balt
ECV	14"rd	14"rd	Balt
ECV	16"rd	16"rd	Balt
CEB	ONE SIZE	-----	Balt, MD, VA

WATER COILS

TITUS

Water Coil

Aluminum plate fins, 10 per square inch. Slip and drive connection. Pipe connection with 1 row, box size 4 thru 8 = 1/2" OD male solder; All other coils (1 and 2 row) = 7/8" OD male solder.

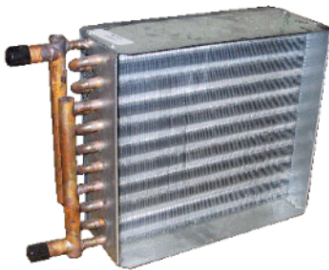

MODEL	BOX SIZE	SIZE	DESCRIPTION	LOCATION
WC - _ R-SZ06	4", 5", 6"	12" x 8" x 5"	1 row or 2 row	Balt, MD, PA
WC - _ R-SZ08	7", 8"	12" x 10" x 5"	1 row or 2 row	Balt, MD, PA
WC - _ R-SZ10	9", 10"	14" x 12.5" x 5"	1 row or 2 row	Balt, MD, PA
WC - _ R-SZ12	12"	16 x 15 x 5"	1 row or 2 row	Balt, MD, PA
WC - _ R-SZ14	14"	20" x 17.5" x 7.5"	1 row or 2 row	Balt, MD (1R only), PA
WC - _ R-SZ16	16"	24" x 18" x 7.5"	1 row or 2 row	Balt, PA
WC - _ R-SZ40	26" x 14"	38" x 18" x 5"	1 row or 2 row	Balt

LOREN COOK

GEMINI CEILING FANS

Centrifugal Ceiling-Wall Cabinet Fan

Loren Cook Gemini fans provide maximum performance, durability, and ease of installation in a wide variety of ceiling (GC) and inline (GN) clean air exhaust applications.

MODEL	CFM @ .1 SP	CFM @ .25 SP	VOLTAGE	LOCATION
GC-120	82 CFM	63 CFM	120v	MD, VA
GC-140	144 CFM	132 CFM	120v	MD, VA
GC-160	173 CFM	162 CFM	120v	MD, VA
GC-180	254 CFM	244 CFM	120v	Balt (EC), MD, VA
GC-240	142 CFM	112 CFM	120v	MD, VA
GC-340	252 CFM	224 CFM	120v	Balt (EC), MD, VA
GC-420	298 CFM	282 CFM	120v	MD, VA
GC-500/520	380 CFM	361 CFM	120v	Balt (EC), MD, VA
GC-640	582 CFM	548 CFM	120v	MD, VA
GC-700/740	823 CFM	775 CFM	120v	Balt (EC), MD, VA
GC-840	1,371 CFM	1,266 CFM	120v	MD, VA
GC-960	1,716 CFM	1,588 CFM	120v	MD, VA

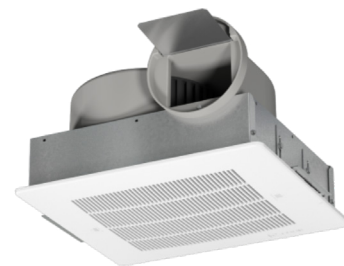

LOREN COOK

GRAVITY VENTILATORS

Spun Aluminum Gravity Vent

Spun aluminum intake/relief ventilator designed for use in both gravity and mechanical ventilation systems. Compact, durable and efficient

MODEL	SIZE	ROOF OPENING	CFM	LOCATION
PR	8"rd	13.5" x 13.5"	215-540	Balt, MD, VA
PR	12"rd	15.5" x 15.5"	445-1140	Balt, MD, VA
PR	16"rd	23.5" x 23.5"	790-2015	MD, VA
PR	20"rd	27.5" x 27.5"	1220-3130	MD, VA
PR	24"rd	31.5" x 31.5"	1755-4510	MD, VA

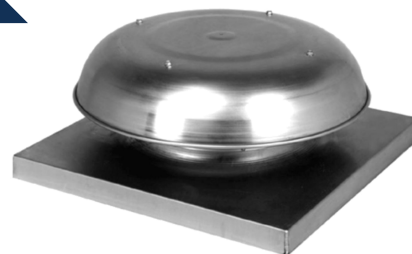

BROAN

FANS

MODEL	CFM RANGE	INLET SIZE	VOLTAGE	LOCATION
BR-FLEXDC110	50-110	4"	120v	Balt



CEILING FANS

PENNBARRY

Ceiling and Inline Centrifugal Fan

Ceiling and Inline centrifugal fans are designed and constructed to create a quiet and reliable product. Extensive combinations of wheel sizes and speeds enable the Zephyr to cover a wide range of CFM. Available in 15 types of models that cover a wide range of performances. Convertible from ceiling to inline installation. Some models have 2 speed motors.



MODEL	CFM @ .1 SP	CFM @ .25 SP	VOLTAGE	LOCATION
Z101S	537	467	120v	PA
Z102H	1435	1338	120v	PA
Z102S	816	691	120v	PA
Z10S/H	469/694	423/664	120v	PA
Z121S	1062	1024	120v	PA
Z12H	1511	1464	120v	PA
Z12S	855	812	120v	PA
Z14	2195	2050	120v	PA
Z3H	83	-----	120v	PA
Z5H	163	128	120v	PA
Z6S/H	123/230	82/166	120v	PA
Z81S	310	239	120v	PA
Z8S/H	272/426	231/377	120v	PA
ZJ1	157	158	120v	PA
ZT	58	48	120v	PA

ROOF FANS

PENNBARRY

Centrifugal Roof Exhauster, Direct Drive and Belt Drive

Domex Direct Drive and Belt Drive Centrifugal Roof Exhausters are designed for roof mounted installations in low to medium pressure applications. Domex Fans are ideal for general purpose exhaust applications including: bathrooms, garages, general kitchen areas, offices, churches, dormitories, factories, large warehouses and other relatively clean air applications.



MODEL	CFM @ .125 SP	CFM @ .25 SP	VOLTAGE	LOCATION
DX08B	155-1019	247-979	120	PA
DX11B	905-2638	535-2555	120	PA
DX12B	654-2833	538-2737	120	PA
DX16B	1453-4660	1880-4569	120	PA
DX06S/R	100	69	115	PA
DX08S/R	111-199	114-142	115	PA
DX10S/R	230-501	166-446	115	PA
DX11VSR	388-659	148-577	115	PA
DX11Q	921	850	115	PA
DX13VSR	479-988	341-917	115	PA
DX13Q	1226	1170	115	PA
DX16VSR	1489-2176	1256-1853	115	PA
DX16Q1	2576	2456	1150	PA

FAN ACCESSORIES

PENNBARRY

ITEM TYPE	DESCRIPTION	USE WITH	LOCATION
Speed Controller	Lektrol Speed Controller	Zephyr/Domex	PA
Vibration Isolators	Isolator Kit	Zephyr	PA
Inline Conversion	Inline Kits for Zephyr fans	Zephyr	PA
Wall Caps	10" Cap	Zephyr	PA
Roof Cap	Sloped Roof Cap 10.25	Zephyr	PA
Backdraft damper	Size 11.25" - 19.75"	Domex	PA
Motor	Various size	Zephyr/Domex	PA



WEATHER CAP

SIZE	THROAT SIZE	CURB DIM'S	CFM	LOCATION
WCC06	7	15" x 15"	93-346	PA
WCC08	9	18.5" x 18.5"	221-827	PA
WCC10	11	18.5" x 18.5"	297-111	PA
WCC12	13	20.5" x 20.5"	493-1845	PA
WCC14	15	24.75" x 24.75"	604-2258	PA
WCC16	17	24.75" x 24.75"	746-2791	PA

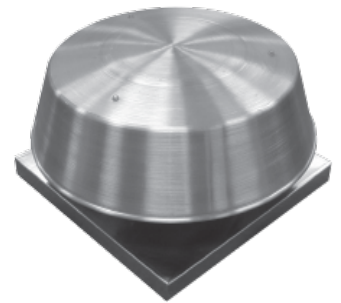

LOREN COOK

ITEM TYPE	DESCRIPTION	USE WITH
Ceiling Grilles	Metal & Plastic Replacement Grilles	All GC's
Speed Controller	5 watt / 10 watt Speed Controller	GC 120-800 / 900
Vibration Isolators	Isolation Kit / Rubber In Shear Isolators	GC 120-700 / 800-900
Inline Conversion	Inline Conversion Kit for 100 Series	GC-120,140,160,180
Thermostat	Thermostat for Cooling Only	All GC's
Wall Caps	WCR 4",6",8"	All GC's
Hinged Base Kit	Hindge for RoofCurb Connections	All Curbs
RP-212	Roof Port Cap 4-Ports	RPC
RPC	Roof Port Cover 13.5" x 13.5"	RC 12"x12"x12"

Availability may vary per location

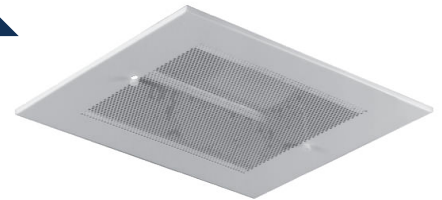

STRAIGHT SIDED

ROOF CURBS

MODEL	SIZE	LOCATION
RC	12" x 12" x 12"H/ OD	Balt, MD, VA
RC	16.5" x 16.5" x 13.5"H /OD	Balt, MD, VA
RC	18.5" x 18.5" x 13.5"H /OD	Balt, MD, VA
RC	22.5" x 22.5" x 13.5"H /OD	Balt, MD, VA
RC	26.5" x 26.5" x 13.5"H /OD	Balt, MD
RC	28.5" x 28.5" x 13.5"H/OD	Balt, MD, VA
RC	30.5" x 30.5" x 13.5"H/OD	Balt, MD
RC	34.5" x 34.5" x 13.5"H/OD	Balt, VA

MODEL	SIZE	LOCATION
SSF	12.5" x 12.5"	PA
SSF	14.5" x 14.5"	PA
SSF	17.5" x 17.5"	PA
SSF	19.5" x 19.5"	PA
SSF	23.5" x 23.5"	PA
SSF	27.5" x 27.5"	PA

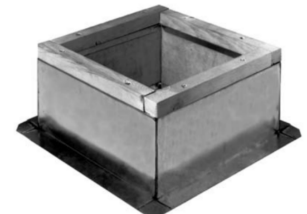

Straight Side Roof Curbs with Wood Nailor

FRAME KIT

MIRO

MODEL	DESCRIPTION	LOCATION
MI-BASE0811STRUT	8 x 11 Roof Support Base w/ Strut (1) Required for FKS	Balt, MD, VA
MI-BASE1818STRUT	18 x 18 Roof Support Base w/ Strut (1) Required for FKS	Balt, MD, VA
MI-FKS-ANGLE	MIRO Angle Piece (1) Required for FKS	Balt, MD, VA
MI-FKS-BOLT	MIRO Bolts (6) Required for FKS	Balt, MD, VA
MI-FKS-BRACKET	MIRO Bracket (1) Required for FKS	Balt, MD, VA
MI-FKS-NUT	MIRO Nut for FKS Bolt (6) Required for FKS	Balt, MD, VA

VOLCANO

MIRO

MODEL	DESCRIPTION	LOCATION
MI-BASE1818STRUT	18 x 18 Roof Support w/o Strut (1) Required for Volcano	Balt, MD, VA
MI-V-BOLT	MIRO Bolt for Canted Applications (1) Required for Volcano	Balt, MD, VA
MI-V-LOCK	MIRO Lock for Canted Applications (2) Required for Volcano	Balt, MD, VA
MI-V-NUT	MIRO Nut for Canted Applications (2) Required for Volcano	Balt, MD, VA
MI-V-SCREW	MIRO Screw for Canted Applications (2) Required for Volcano	Balt, MD, VA
MI-V-STRUT	MIRO Volcano Strut for use with 18x18 Support (1) Required	Balt, MD, VA
MI-V-WASHER	MIRO Washer for Canted Applications (2) Required for Volcano	Balt, MD, VA

RAILS

MODEL	SIZE	DESCRIPTION	LOCATION
EQUIPMENT RAIL	24" x 3.5"	18 gauge galvanized straight rail, rated at 480lbs	Balt, PA
EQUIPMENT RAIL	36" x 3.5"	18 gauge galvanized straight rail, rated at 480lbs	MD, VA, PA
EQUIPMENT RAIL	48" x 3.5"	18 gauge galvanized straight rail, rated at 480lbs	MD, VA, PA
EQUIPMENT RAIL	60" x 3.5"	18 gauge galvanized straight rail, rated at 480lbs	PA
EQUIPMENT RAIL	72" x 3.5"	18 gauge galvanized straight rail, rated at 480lbs	PA

DAMPERS

RUSKIN

DIBD2 DYNAMIC FD



UL 555 1.5 Hr. Dynamic, Curtain Type, Optional Sleeve

The IBD2A is a UL555 1-1/2 Hour Rated Classified Dynamic Fire Damper. It features a vertical and horizontal closure spring operation for assured closure under air flow (fans on) in HVAC systems. Features galvanized steel construction with a maximum velocity 4,000 fpm and a maximum 4" static pressure.

SIZE	TYPE	LOCATION
6 x 4	"A"-spring	MD, VA
6 x 6	"A"-spring	Balt, MD, VA
8 x 4	"A"-spring	MD, VA
8 x 6	"A"-spring	Balt, MD, VA
8 x 8	"A"-spring	Balt, MD, VA
10 x 6	"A"-spring	Balt, MD, VA
10 x 8	"A"-spring	Balt, MD, VA
10 x 10	"A"-spring	Balt, MD, VA
12 x 6	"A"-spring	Balt, MD, VA
12 x 8	"A"-spring	Balt, MD, VA
12 x 10	"A"-spring	Balt, MD, VA
12 x 12	"A"-spring	Balt, MD, VA
14 x 6	"A"-spring	Balt, MD, VA
14 x 8	"A"-spring	Balt, MD, VA
14 x 10	"A"-spring	Balt, MD, VA
14 x 12	"A"-spring	Balt, MD, VA
14 x 14	"A"-spring	Balt, MD, VA

SIZE	TYPE	LOCATION
16 x 6	"A"-spring	MD, VA
16 x 8	"A"-spring	Balt, MD, VA
16 x 10	"A"-spring	Balt, MD, VA
16 x 12	"A"-spring	Balt, MD, VA
16 x 14	"A"-spring	Balt, MD, VA
16 x 16	"A"-spring	Balt, MD, VA
18 x 8	"A"-spring	Balt, MD, VA
18 x 10	"A"-spring	Balt, MD, VA
18 x 12	"A"-spring	Balt, MD, VA
18 x 14	"A"-spring	Balt, MD, VA
18 x 16	"A"-spring	MD, VA
18 x 18	"A"-spring	Balt, MD, VA
20 x 6	"A"-spring	MD, VA
20 x 8	"A"-spring	MD, VA
20 x 10	"A"-spring	Balt, MD, VA
20 x 12	"A"-spring	Balt, MD, VA
20 x 14	"A"-spring	Balt, MD, VA

SIZE	TYPE	LOCATION
20 x 16	"A"-spring	Balt, MD, VA
20 x 18	"A"-spring	MD, VA
20 x 20	"A"-spring	Balt, MD, VA
22 x 10	"A"-spring	MD, VA
24 x 6	"A"-spring	MD, VA
24 x 8	"A"-spring	Balt, MD, VA
24 x 10	"A"-spring	Balt, MD, VA
24 x 12	"A"-spring	Balt, MD, VA
24 x 14	"A"-spring	Balt, MD, VA
24 x 16	"A"-spring	MD, VA
24 x 18	"A"-spring	Balt, MD, VA
24 x 20	"A"-spring	Balt, MD, VA
24 x 24	"A"-spring	Balt, MD, VA
6"rd	"R"	Balt, MD, VA
8"rd	"R"	Balt, MD, VA
10"rd	"R"	Balt, MD, VA
12"rd	"R"	Balt, MD, VA
—	165 fusible link	MD, VA

RUSKIN

CFD/ CFDR

UL 555C Classified Ceiling Fire Damper, Rectangular and Circular

The CFD2 is a UL555C Classified Ceiling Fire Damper. It features fire and heat protection where HVAC components penetrate the ceiling membrane. Equipped with fusible link at no extra charge. Galvanized steel construction.



MODEL	TYPE	WARHOUSE LOCATION
CFD	6 x 6	Balt, MD, VA
CFD	8 x 8	Balt, MD, VA
CFD	9 x 9	MD, VA
CFD	10 x 10	Balt, MD, VA
CFD	12 x 12	Balt, MD, VA
CFD	15 x 15	MD, VA
CFD	18 x 18	MD, VA

MODEL	TYPE	WARHOUSE LOCATION
CFD	22 x 22	Balt, MD, VA
CFDR	6"rd	Balt, MD, VA
CFDR	8"rd	Balt, MD, VA
CFDR	10"rd	Balt, MD, VA
CFDR	12"rd	Balt, MD, VA
CFDR	14"rd	MD, VA
CFDR	15"rd	MD, VA
RCF - blanket	24 x 24	MD, VA

RUSKIN

BDD/ BD2A

Commercial Backdraft Damper

The Ruskin Backdraft damper offers backdraft features a non-metallic blade to blade seal which provides quiet operation during the highest spot velocities. Corrosion resistant aluminum construction. Blades that overlap the frame for optimal protection.

MODEL	SIZE	FRAME TYPE	MATERIAL	FINISH	LOCATION
BD2A1	12 x 12	Channel	Aluminum	Mill	Balt, MD, VA
BD2A1	18 x 18	Channel	Aluminum	Mill	Balt, MD, VA
BD2A2	24 x 12	Channel	Aluminum	Mill	Balt, MD, VA
BD2A2	24 x 24	Channel	Aluminum	Mill	Balt, MD, VA



ACCESS DOORS

RUSKIN

Hinged Access Door

The Single Skin Access Door is constructed of galvanized steel and features quick, easy installation wherever duct access is needed. Manual locks, assuring tight door closure.



MODEL	SIZE	FINISH	LOCATION
ADH	6 x 6	Mill	Balt, MD, VA
ADH	8 x 8	Mill	Balt, MD, VA
ADH	10 x 10	Mill	Balt, MD, VA
ADH	12 x 12	Mill	Balt, MD, VA
ADH	14 x 14	Mill	Balt, MD, VA
ADH	16 x 16	Mill	Balt
ADH	18 x 18	Mill	Balt, MD, VA

Cam Latch Door

Double cam lock steel duct access door.

MODEL	SIZE	FINISH	LOCATION
ADC	6 x 6	Mill	Balt, MD, PA
ADC	8 x 8	Mill	Balt, MD, PA
ADC	10 x 10	Mill	Balt, MD, PA
ADC	12 x 12	Mill	Balt, MD, PA
ADC	14 x 14	Mill	Balt, MD, PA
ADC	16 x 16	Mill	Balt, PA
ADC	18 x 18	Mill	Balt, MD, PA
ADC	20 x 20	Mill	PA
ADC	24 x 24	Mill	Balt, PA
PA different manufacturer			

Round Access Door

The ADR and ADF oval access doors for rectangle and round duct are constructed of galvanized steel.

MODEL	SIZE	SPIRAL SIZE	LOCATION
ADR	10 x 6	8"	Balt
ADR	10 x 6	10"	Balt
ADR	10 x 6	12"	Balt
ADR	10 x 6	14"	Balt

ELF375DX

RUSKIN

Stationary Louver

The ELF375DX Stationary Louver has a 4" deep frame, drainable blades, and a 37.5 degree blade angle. It features 54% free area, has excellent water penetration performance, minimizes water cascading with its drain gutters in its blade, continuous line appearance up 120", and all aluminum construction for low maintenance and high resistance corrosion.



MODEL	TYPE	FRAME TYPE	MATERIAL	FINISH	LOCATION
ELF375DX	12 x 12	Flanged	Aluminum	Mill	Balt, MD, VA
ELF375DX	18 x 18	Flanged	Aluminum	Mill	Balt, MD, VA
ELF375DX	24 x 12	Flanged	Aluminum	Mill	Balt, MD, VA
ELF375DX	24 x 24	Flanged	Aluminum	Mill	Balt, MD, VA
ELF375DX	36 x 24	Flanged	Aluminum	Mill	Balt, MD, VA
ELF375DX	48 x 24	Flanged	Aluminum	Mill	Balt, MD, VA

RAYMON DONCO

TRANSITIONS/REDUCERS

MODEL	SQUARE SIZE	NECK SIZES AVAILABLE	LOCATION
Square to Round	6 x 6	6"rd	Balt, MD, VA, PA
Square to Round	8 x 8	8"rd	Balt, MD, VA, PA
Square to Round	9 x 9	6, 8"rd	Balt, MD, VA, PA
Square to Round	10 x 10	6-10"rd	Balt, MD, VA, PA
Square to Round	12 x 12	6-12"rd	Balt, MD, VA, PA
Square to Round	15 x 15	6-14"rd	Balt, MD, VA, PA
Square to Round	18 x 18	6-16"rd	Balt, MD, VA, PA
Square to Round	22 x 10	8-10"rd	Balt, PA
Square to Round	22 x 22	6-16"rd	Balt, MD, PA
Square to Round	22 x 22	18"rd	Balt, PA
Round to Round	6"	4" rd	Balt, MD
Round to Round	6"	5"rd	Balt
Round to Round	8"	6"rd	Balt, MD, VA
Round to Round	10"	6"rd, 8"rd	Balt, MD, VA
Round to Round	12"	10"rd	Balt, MD, VA
Round to Round	14"	12"rd	Balt, MD, VA

Sizes and availability may vary per location

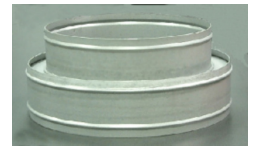
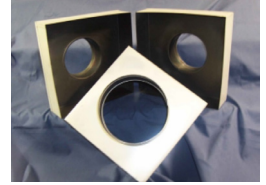

CL WARD/ELGEN

SHEETMETAL

MODEL	SIZE	NECK SIZES AVAILABLE	LOCATION
Round to Round	6"	Tapered Transition to 4", 5"	Balt
Round to Round	8"	Tapered Transition to 6"	Balt
Round to Round	10"	Tapered Transition to 6", 8"	Balt
Round to Round	12"	Tapered Transition to 6", 8", 10"	Balt
Round to Round	14"	Tapered Transition to 12"	Balt
Round to Round	15"	Tapered Transition to 14"	Balt
Snap Lock Pipe	4"rd-18"rd	60" length w/ crimped end	Balt, MD, VA, PA
90° Elbow	4"rd-18"rd	Adjustable w/ crimped end	Balt, MD, VA, PA
Air Tite w/ Dpr	4"rd-18"rd	RD takeoff w/ adhesive back	Balt, MD, VA, PA
Air Tite w/ Stdoff	6"-16" rd	RD takeoff w/ adhesive back, standoff	Balt, MD
HETO	4"rd-14"rd	Rectangular to RD w/ adhesive back	Balt, MD, VA, PA
Air Tite (No Dpr)	6" rd-12"rd	RD to RD w/ adhesive back	Balt
End Caps	6" rd-16"rd	End Caps/Tee Cap	Balt, MD, VA, PA
Tee Joint	4"rd-14"rd	15 Inch Long Tee	Balt, MD, VA

Sizes and availability may vary per location



DUCT SEALER

ACCESSORIES



MODEL	DESCRIPTION	LOCATION
Duct Sealer	Sheet Metal Duct Sealant Gallons, Caulk-style bottles, and brushes available	Balt, MD, VA

FLEX DUCT

MODEL	SIZE	INSULATION	DESCRIPTION	LOCATION
FLEX-R42	4"rd-18"rd	R4.2, R6, R8	Double-ply polyester core, wire helix	Balt, MD, VA, PA

Jacket color and sizes may vary per location
High pressure and acoustically rated flex in stock at PA location

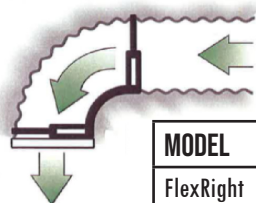

ACCESSORIES

TITUS

MODEL	SIZE	DESCRIPTION	LOCATION
FlexRight	FlexRight	Forms 90° Elbow for Flexible Duct, Adjustable from 4" - 16"	Balt, MD, VA, PA
P/P00PT18	P/P00PT18	#26 White Spray Paint (to match Titus standard colors)	Balt, MD, VA, PA
60150039	60150039	#84 Black Spray Paint (to match Titus standard colors)	Balt, MD, VA, PA
60150040	60150040	#01 Aluminum Spray Paint (to match Titus standard colors)	Balt, PA

STRAPS, BANDS

METALS

MODEL	DIAMETER	SIZE	DESCRIPTION	LOCATION
FDT36	10"	36"L	Nylon Duct Bands (zip tie type)	Balt, MD, VA, PA
FDT48	14"	48"L	Nylon Duct Bands (zip tie type)	Balt, PA
SSDC	8.5"-16.25"	-----	Stainless Steel Bands	Balt, MD, VA, PA
HANGER STRAP	-----	120" x 1"	18 gauge duct hanger straps	Balt, MD

SPIRAL GRILLES

DONCO



MODEL	DUCT SIZE	WIDTH	HEIGHT	CFM RANGE	LOCATION
DO-USPG1003	10"-36"	10	3	28-100	Balt
DO-USPG1006	12"-36"	10	6	75-258	Balt
DO-USPG1203	10"-36"	12	3	55-192	Balt
DO-USPG1206	12"-36"	12	6	80-290	Balt
DO-USPG1208	20" - 36"	12	8	120-415	Balt
DO-USPG1603	10"-36"	16	3	59-207	Balt
DO-USPG1606	12"-36"	16	6	120-415	Balt
DO-USPG1608	20"-36"	16	8	155-536	Balt
DO-USPG2008	20"-36"	20	8	213-746	Balt
DO-USPG2408	20"-36"	24	8	560-896	Balt

GRIPPLE

HF

Hang Fast

Gripple Hang Fast (HF) range is used to suspend, brace, and secure any services. Up to 6 times faster to install than traditional hanging systems. Ready-to-use kit. Improves work comfort and safety.

LENGTH (FT)	NO. 2 (100 LBS)	NO. 3 (200 LBS)	LOCATION
5	HF2-LG-5FT	HF3-LG-5FT	Balt
10	HF2-LG-10FT	HF3-LG-10FT	Balt, MD (HF2 only)
15	HF2-LG-15FT	HF3-LG-15FT	Balt
30	HF2-LG-30FT	HF3-LF-30FT	Balt

Small Cable Cutter suitable for use with sizes No. 1-4



EASTERN SHEET METAL

SPIRAL & FITTINGS

Spiral Duct and Fittings

Availability varies by location, call to confirm.

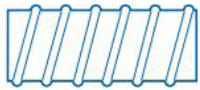

SP



PCPT



FCPT

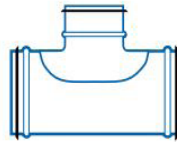

PTT

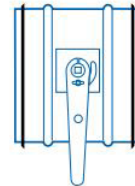

DT



PBT



CTOT



ECT

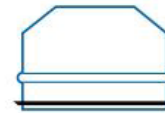

PECT



PRDT



PRDBT

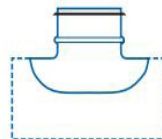

PFTT

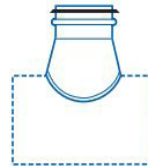

FTCT

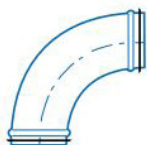

PE90T

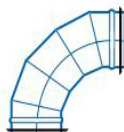

E90T



E45T



PE45T

Spiral & Spiral Fittings

MODEL	SP	(P) E45T	(P) E90T	PTT	PCPT	PBT /CTOT	DT	(P) ECT	FCP	TOT
DIA SIZE	10FT SPIRAL PIPE	45DEG ELBOW	90DEG ELBOW	90DEG CNTRD TEE	PIPE COUP	BELLMOUTH/ CONICAL TAKE OFF	PIPE VOLUME DAMPER	END CAP	FEMALE PIPE COUP.	STRAIGHT TAKEOFF
4"	●	●	●	●	●	●	●	●	●	●
6"	●	●	●	●	●	●	●	●	●	●
8"	●	●	●	●	●	●	●	●	●	●
10"	●	●	●	●	●	●	●	●	●	●
12"	●	●	●	●	●	●	●	●	●	●
14"	●	●	●		●	●		●	●	●
16"	●	●	●		●	●		●	●	●
18"	●	●	●		●	●		●	●	●
20"	●	●	●		●	●		●	●	●
22"	●	●	●		●	●		●	●	●
24"	●	●	●		●	●		●	●	●

(P) RDT (REDUCERS)		PFTCT/ FTCT* (SADDLE TAPS)	
SIZE	SMALL DIA. SIZE	BRANCH DIA. SIZE	MAIN PIPE DIA. SIZE
6"	4"	4"	4-6"
8"	6"	6"	6-18"
10"	6-8"	8"	8-18"
12"	8-10"	10"	10-24"
14"	8-12"	12"	12-24"
16"	10-14"	14"	14-24"
18"	12-16"	16"	16-24"
20"	14-18"	18"	18-24"
22"	16-20"	20"	20-24"
24"	18-22"	22"	22-24"
-----	-----	24"	24"

EASTERN TIGHT Fittings will save you money and reduce installation time by eliminating joint sealing. They feature a triple lipped EPDM rubber gasket, held in place with a 180° hemmed edge, that provides a reliable, airtight seal. EASTERN TIGHT Fittings are suitable for use for temperatures ranging from -20° F to 212° F.

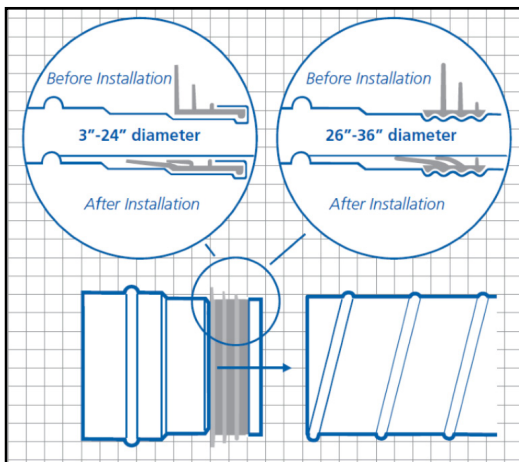

Fittings are secured to the duct with self tapping screws uniformly located around the circumference per SMACNA standards.

EASTERN TIGHT Fittings have been independently tested and can be used to meet SMACNA Class 3 leakage standards for -2" WG to +10" WG.



NOTES AND TERMS & CONDITIONS ABOUT THIS CATALOG

PERFORMANCE DATA

CFM information for the air devices in the enclosed catalog is based on cataloged information. The maximum flow is based on 30 NC (unless noted otherwise). The minimum flow is based on the lowest CFM cataloged. This information is to be used for reference only. CFM data listed is based on cataloged laboratory published performance. Contact an H&B salesman for selection assistance or to request the latest catalog for performance information.

FINISH

Air Devices are standard factory White Finish unless noted otherwise.

MATERIAL

Air Devices are made of Steel unless noted otherwise.

PAYMENT TERMS

NET 30 days from date of invoice for customers with a current account with H&B Engineered Products, Inc.

We also accept Visa, MasterCard, American Express, Discover, money orders & certified checks.

SHIPPING

All orders shipped 'best way' determined by Warehouse Manager unless quoted otherwise.

All orders are PLUS FREIGHT, unless negotiated with an H&B salesman. Delivery is to be made to a business address only. Deliveries with additional services (lift-gate, trucker notification, etc.) may be subject to additional charges. Job site deliveries are not recommended. We try to coordinate the best we can but we are not responsible for lost or damaged shipments. Job site name and phone number is required for job site deliveries.

WARRANTIES

Subject to manufacturer's terms and conditions. Contact an H&B salesman for warranty information.

RETURNS

Returns must be made within (30) days of invoice date and must be in original manufacturer's box. Box and products are to be undamaged and free of all defects and installation markings. Returns are subject to a 25% restocking fee. Shipping charges are not refundable. All factory orders are special order and are not eligible to be returned to any warehouse or to the factories.

PRICING

Contact an H&B salesman for a price list or call a warehouse directly to be quoted on any item in this catalog.

TERRITORIES

All items in this catalog may be picked up at its corresponding location by any customer.

However, due to manufacturer's territorial boundaries, we are not able to ship some products to locations outside of the represented territory.

Contact H&B salesperson for more information.





12500 Baltimore Avenue, Unit F
Beltsville, Maryland 20705
Phone: 301-918-0241
E-mail: info@hbproducts.com
Website: www.hbproducts.com



14 Union Hill Road
Conshohocken, PA 19428
Phone: 215-879-4700
E-mail: info@johnfscanlan.com
Website: www.johnfscanlan.com